

Converting a '56-'62 Chevy Non-positraction rear-end to a positraction rear using an Eaton posi unit.

Tom Parsons

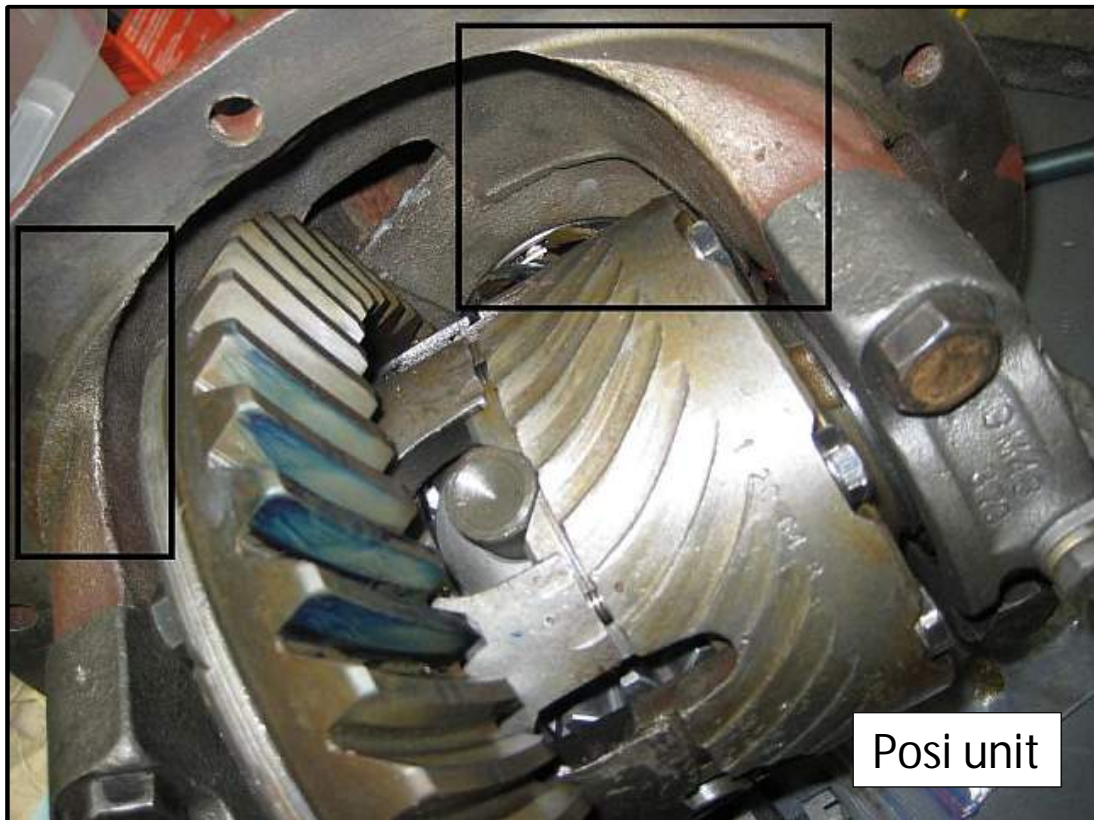
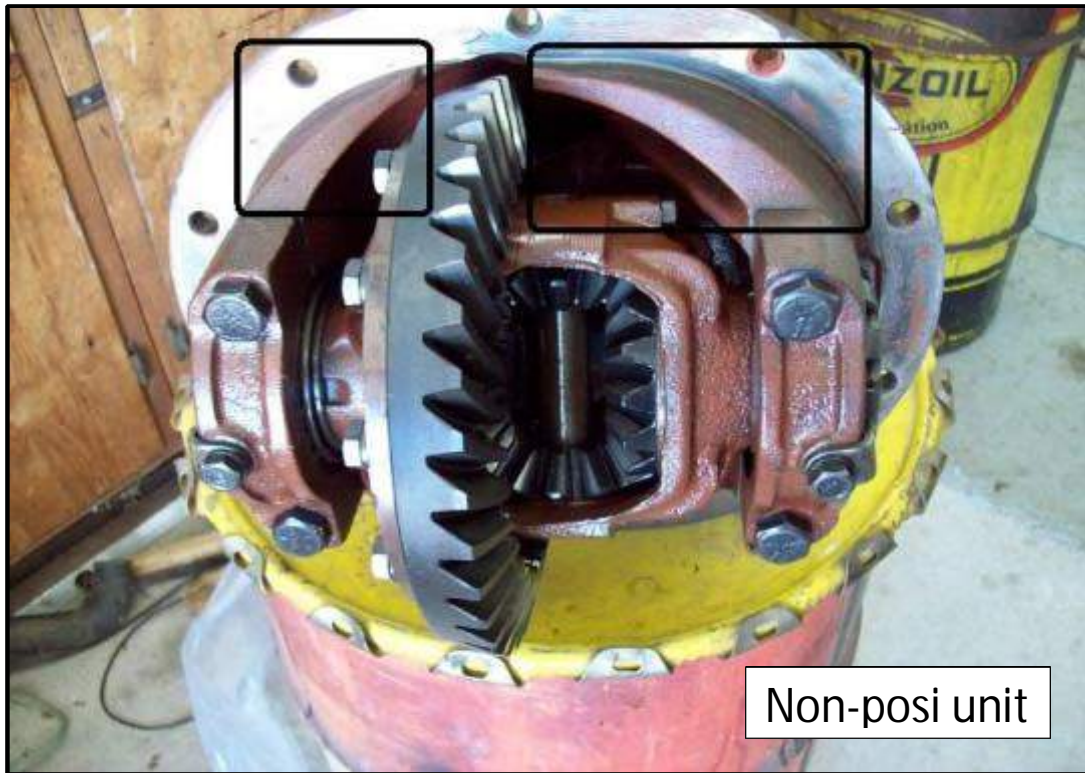

Converting a '56 -'62 Chevy Non-positraction rear-end to a positraction rear using an Eaton posi unit.

<http://forums.corvetteforum.com/c1-and-c2-corvettes/2402216-repeat-of-converting-56-62-non-posi-to-posi.html>

Several months ago, I posted a somewhat detailed procedure for converting the '56 -'62 NON-posi rears to positraction by installing an Eaton positraction unit. This also applies for '55 -'64 passenger car rears. The same would be applicable for installing an original style factory GM positraction unit, but those are becoming so scarce and expensive that it is much more practical and economical to just buy one of the new Eaton positraction units and install it. Once installed, no one will know if it's a factory positraction unit or an Eaton unit.

I'm repeating this post because I made some changes to my Photobucket account and the pictures in the original post no longer appear.

This article will be specifically directed at converting the '55 -'64 Chevrolet full -size passenger car and '56 -'62 Corvette **NON-positraction rear end to positraction using an Eaton aftermarket positraction unit.** But, much of the information will be applicable to the original factory positraction units (originally made for GM by DANA).

I am not going to include detailed assembly and setup procedures in this article. Here is a link to the factory '56 Chevrolet rear-end rebuilding procedures which is applicable for '55 -'64 rear-ends and is very complete. This manual was provided by courtesy of Keith Hardy and is located in the Chevytalk forum. This manual can be downloaded and printed if you wish to add it to your library.

<http://chevy.oldcarmanualproject.com/booklets/56top03/index.htm>

There were primarily 2 different rear-end center cases between '55 and '64 along with multiple casting numbers, but the two primary differences were the '55-'56 case and the '57-'64 case. To convert the '55-'56 rear to positraction is a VERY straight-forward process of installing the ring gear on the positraction unit, installing the positraction with ring gear in the case, and then setting the bearing preload and backlash. **THERE IS NO NEED TO REMOVE THE PINION GEAR** to convert a '55 -'56 rear to positraction. Also, depending on the ring gear used with a positraction unit in a '55-'56 case (ESPECIALLY if the ring gear is an original '55-'56 ring gear), it MAY be necessary to use a ring gear spacer. The reason for the spacer is that original '55 -'56 ring gears are thinner than '57 -'64 ring gears. Ring-gear spacers are readily available from the aftermarket sources. Also, for added information, the '55 -'56 case is not as "beefy", thus, not quite as strong as the '57 -'64 case.

The conversion that was done in this article is on a '57 center section which eventually is going into a customer's '52 Chevy with a '57 passenger car axle housing.

Note: for reference, an exploded diagram of the rear axle is attached at the end of the article.

Below is a '55-'56 style case with a positraction unit already installed.

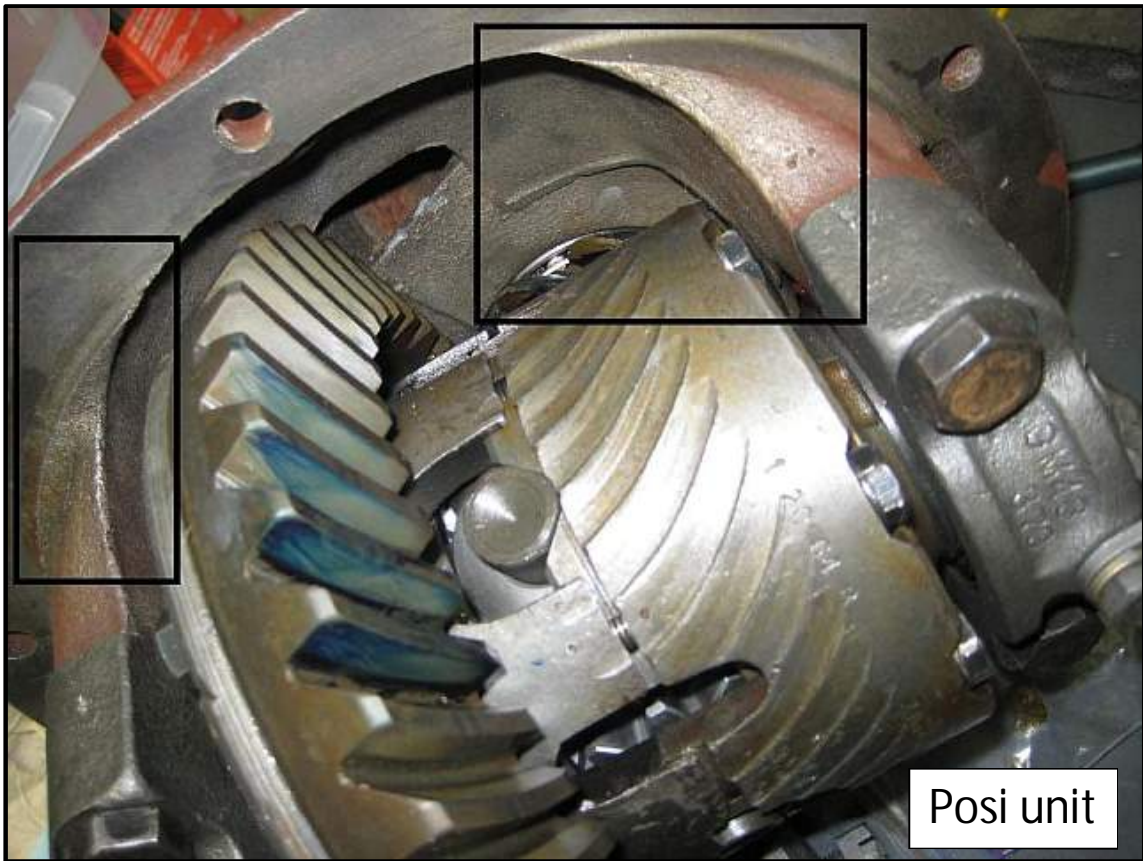

This is a '57-'64 style NON-positraction rear before disassembly. As can be clearly seen, the '57-'64 case has thicker, stronger webbing for the carrier bearings.

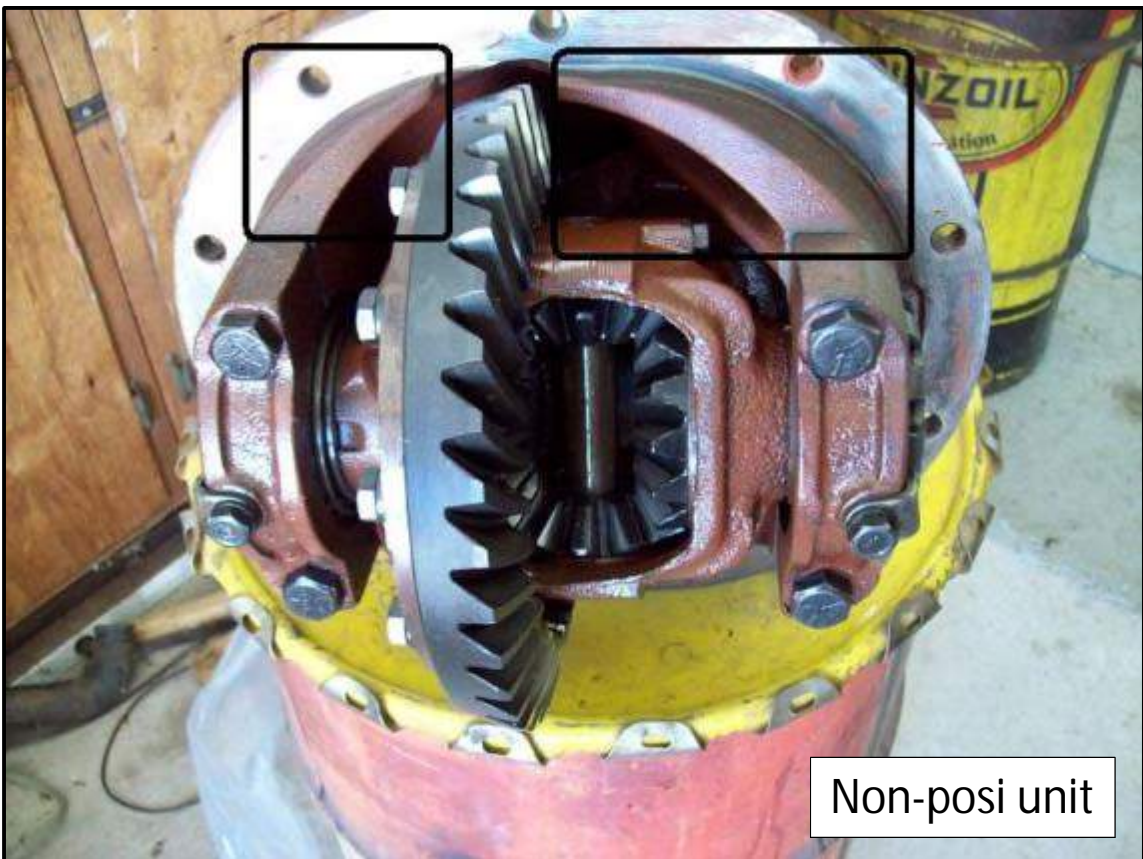

The photo below shows the non-positraction case after disassembly and before cleaning. Notice the +1 which was hand painted on the assembly line during the original factory assembly process. This +1 marking is related to the shim thickness installation on the pinion gear.

Also notice that there are two protrusions cast inside the case. The squared off one (red arrow) is in all cases; both positraction and non-positraction. The angled protrusion (green arrow), or gusset, is ONLY in the '57 -'64 NON-positraction cases.

THIS IS WHERE A MODIFICATION OF THE '57-'64 NON-POSITRACTION CASE IS REQUIRED BEFORE A POSITRACTION UNIT CAN BE INSTALLED. A portion of this gusset must be removed to provide clearance for the positraction unit, and it does not matter if an original factory style positraction is used or an aftermarket positraction unit such as the Eaton is used.

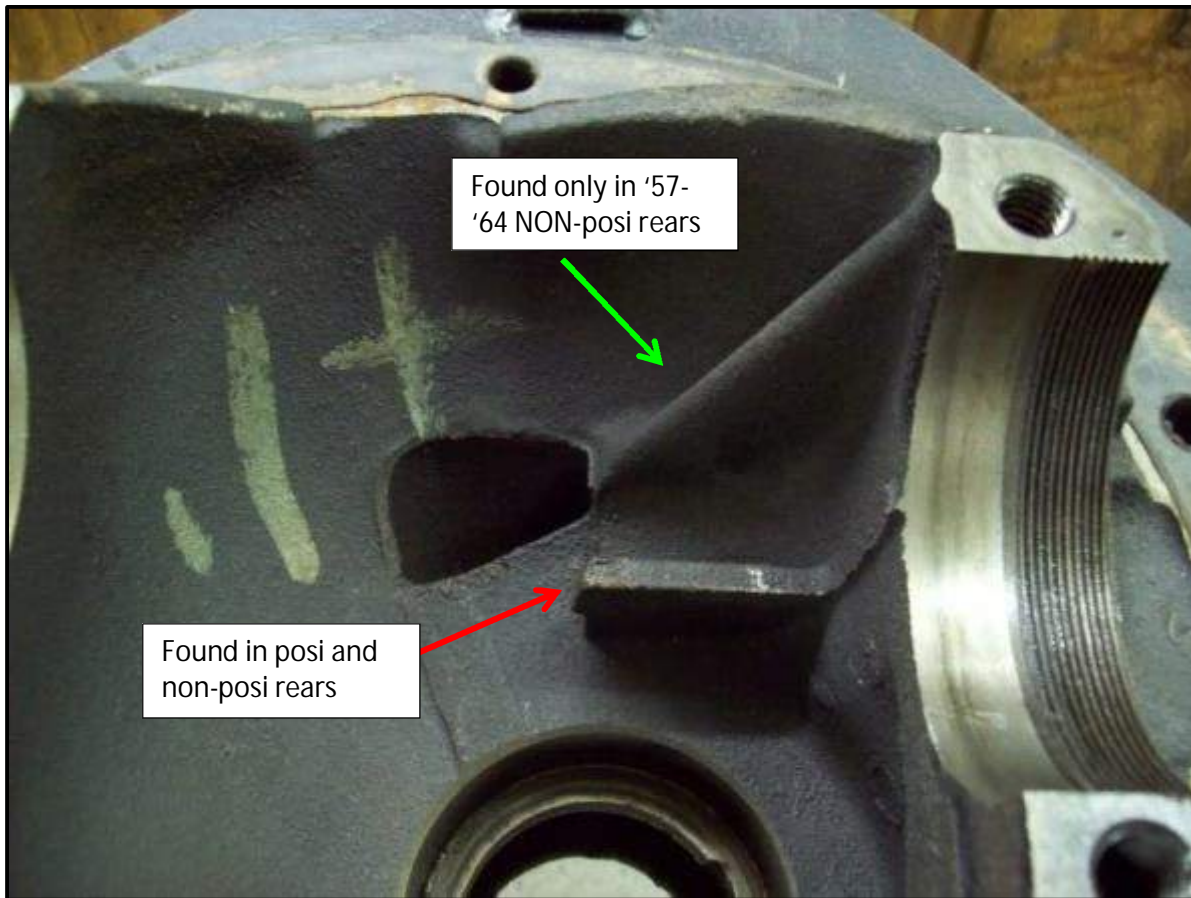

I use a die grinder and a thin cutoff disc to remove the major portion of the gusset. The gusset only needs to be cut off about 1 ½ inches from the mating surface for the bearing cap. It is important to remove the portion of the gusset ALL THE WAY to the inner wall of the case (See photo below).

Here is the case after the portion of the gusset is removed. After cutting the larger portion of the gusset with a cutoff disc, I use a rotary file in the die grinder to remove the remainder of the gusset, then a small sanding disc to smooth out the grinding marks. I also smoothed out the parting lines from the casting mold.



The next step is blasting the case inside and out. I concentrate blasting on the areas where the grinding was done just to make an even finish all over. This step is not necessary, but this is how I do it.

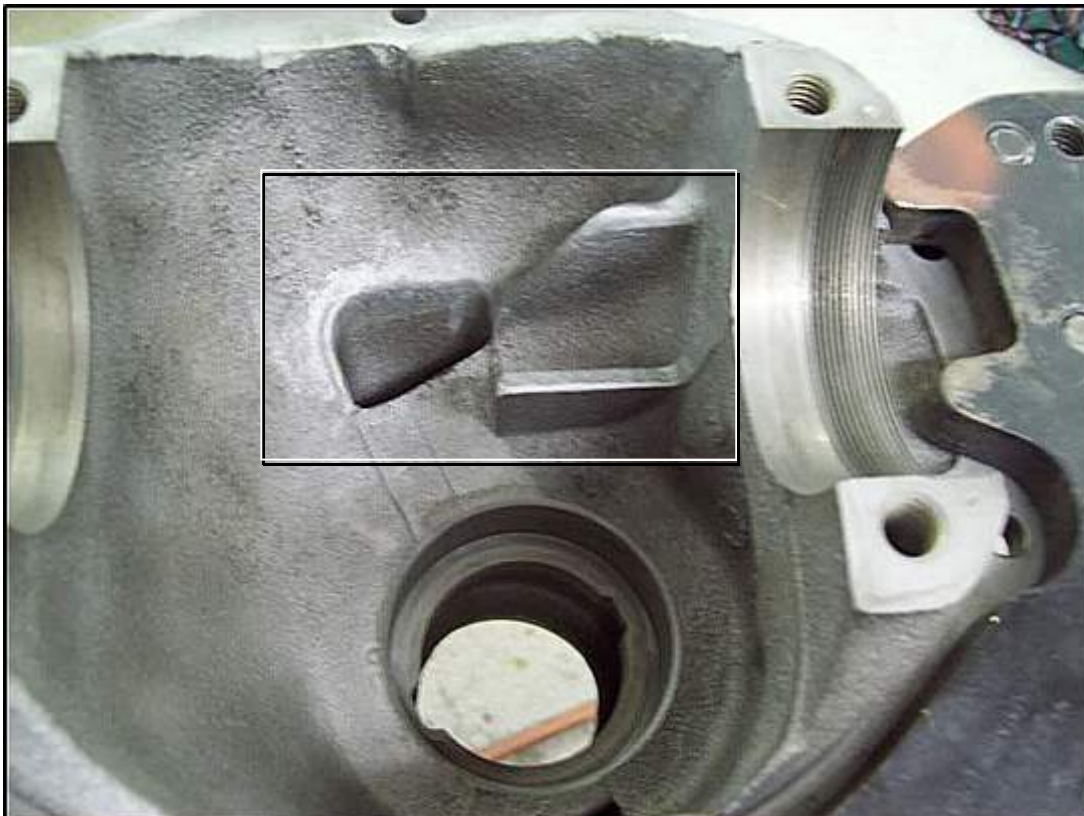



Once the case is cleaned and blasted, it is much easier to read the casting numbers and casting date on the driver side of the case and the ratio code and assembly date (AB 523-May 23) on the passenger side.



Often the stamped code and assembly date seen below is VERY difficult to find and usually requires thoroughly cleaning the case down to the bare cast-iron.



Painting the case is optional and it's your choice. Many early cases were painted a red oxide inside and outside, similar to that below.

As you see below, I hand brushed green paint to attempt to duplicate the original marking from the factory. This step is totally unnecessary because it will never be seen after installation in the axle housing, but some people like it. No extra charge!



As you will also note, once the housing is painted on the outside, the numbers and codes are not quite so easy to distinguish.



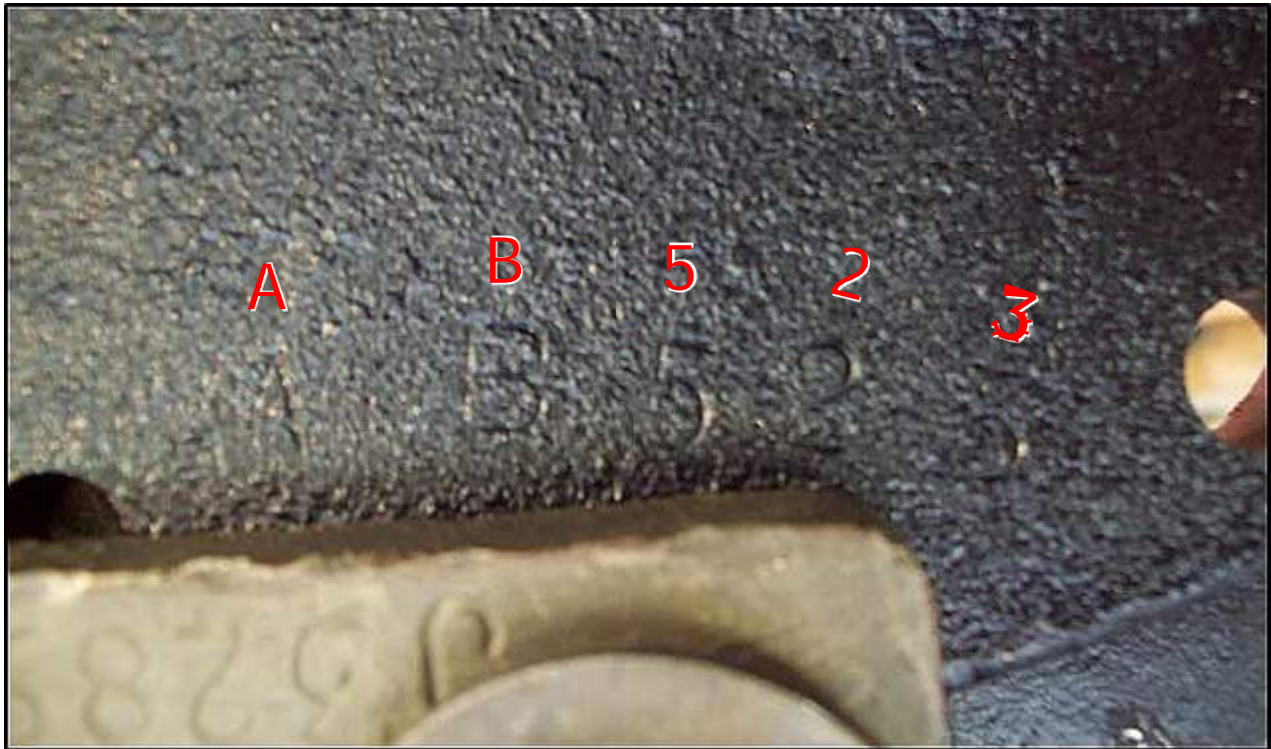

Here are all the parts that will go into this case.

This customer wanted a brand new ring and pinion gear set. However, I'd like to mention that if an original Chevy ring and pinion gear set in good condition is available, use it! The original Chevy gears are excellent quality and there is no reason to not re-use them. This is also the **new Eaton positraction unit**, all new bearings, crush sleeve and pinion seal.



The first step in assembly is **to drive in the new pinion races**. I have taken a pair (front/rear) of old races and slightly ground down the outer diameter so that they just slip into the holes in the case. **I use the old races to do the final driving of the new races to the bottom of their respective holes.** Since the gears are new, even though the new pinion is marked for pinion depth, I have quit trying to set the depth. I start out selecting a pinion shim of **0.030 in**, slip it on and then press on the pinion bearing.



Lightly lube the pinion bearings and slip the pinion into the case, slip on the crush sleeve (--- **NO PINION SEAL YET**---), then the front pinion bearing, the yoke, big washer and finally the pinion nut. Depending on the condition of the old pinion nut, you may or may not choose to re-use it. For an original pinion nut that has never been removed, I frequently re-use it (I'll get a lot of flak over this!).



Years ago, I made my own **companion-flange-holding-tool** from a piece of 1/2-in steel plate. I cut it to shape with my die grinder and cutoff disc. Then I drilled the holes for the yolk and drilled four holes for the corners to make the square hole to fit a 3/4in drive breaker bar into. I also drilled two holes for attachment of a very long handle which I made from a piece of steel rod.

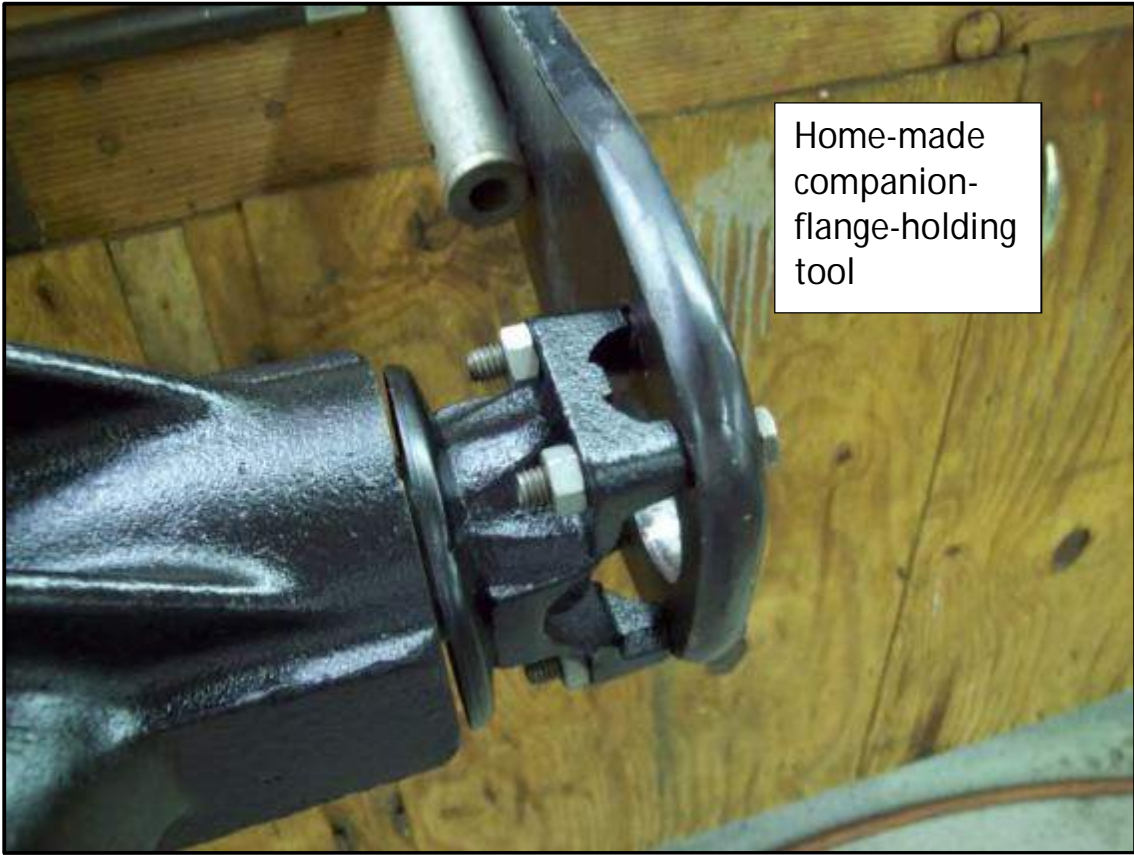

Home-made
companion-
flange-holding
tool





Next, bolt the ring gear onto the positraction unit and drive the new carrier bearings onto the positraction unit. Place the bearing races on the bearings and set the entire assembly into the case. I'm not going into detail here because **all of the information for assembly is in the 56 Chevy rear-end manual located at the link at the beginning of this article.** (<http://chevy.oldcarmanualproject.com/booklets/56top03/index.htm>).

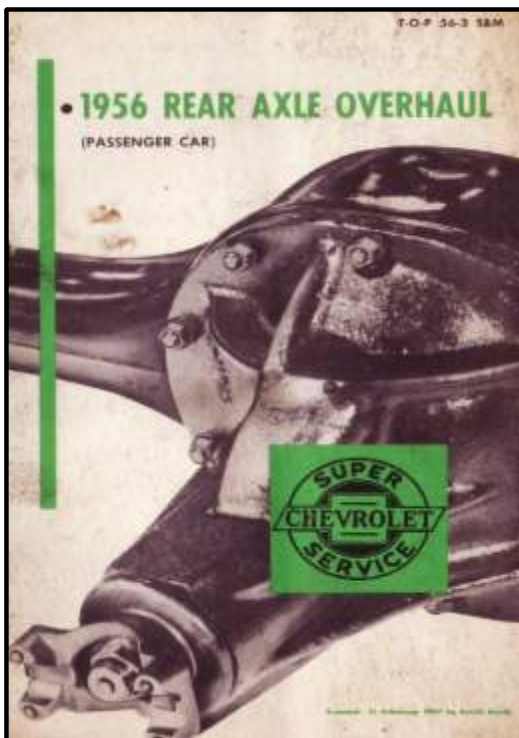

Or
here→

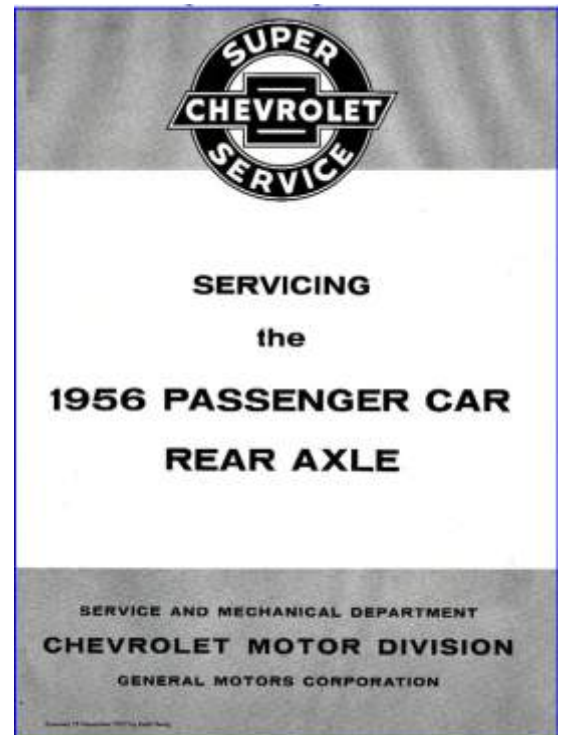

<http://chevy.oldcarmanualproject.com/booklets/56top03/index.htm>

<http://chevy.oldcarmanualproject.com/trans/56spcra/56spcra00.html>

You can see from the next two pictures where the removed portion of the gusset has provided plenty of clearance for the positraction unit.

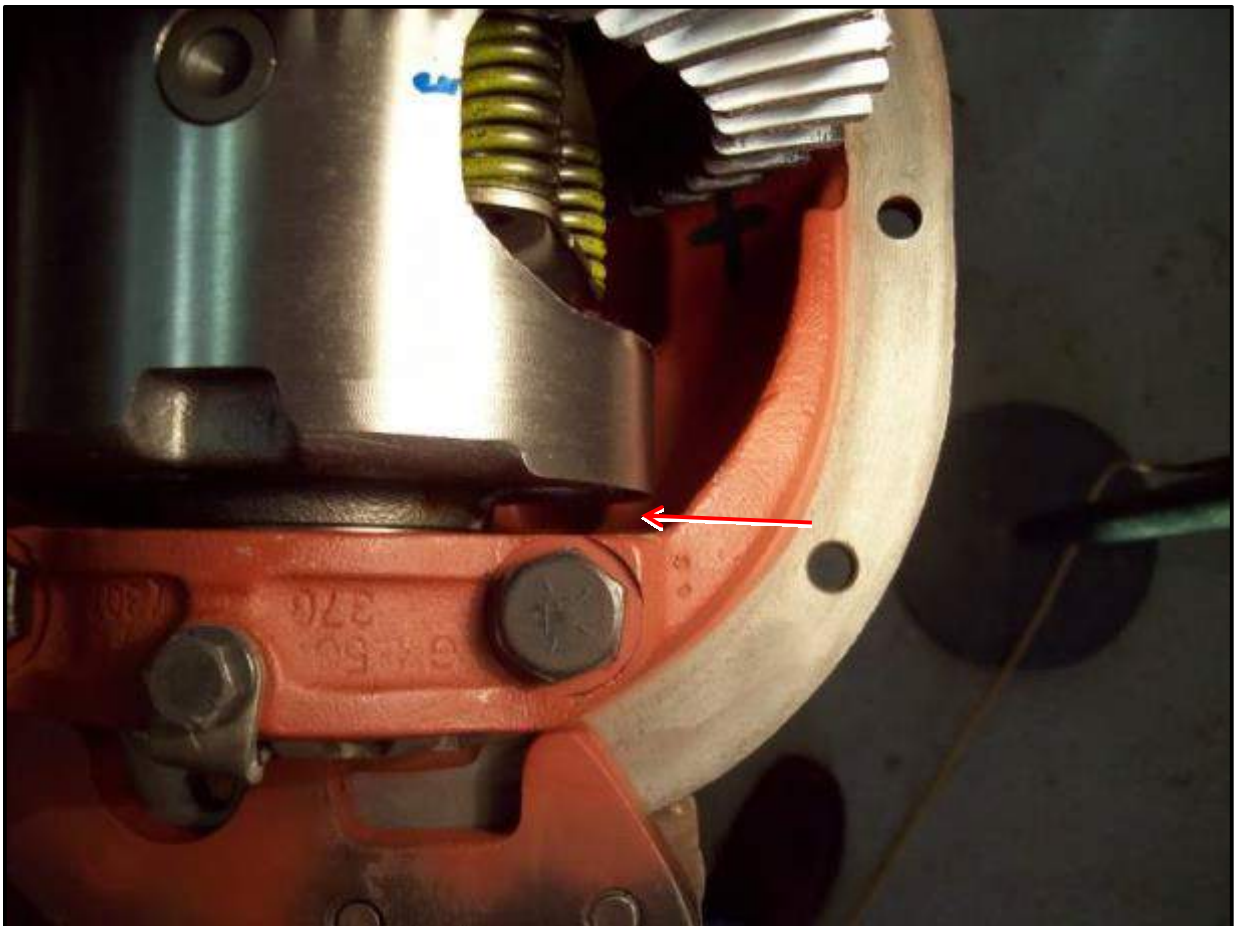
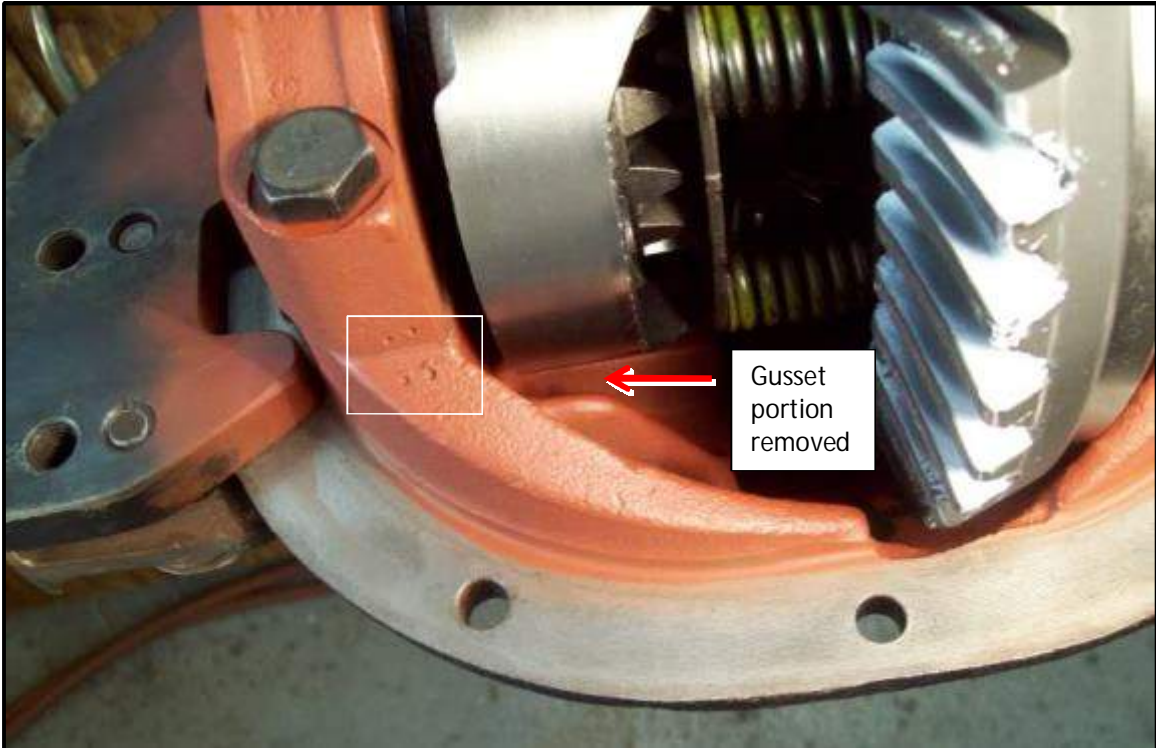

Also, notice the two punch marks on the case and the cap. I do this (failed to mention it much earlier) prior to disassembly so that there is no confusion which cap goes on which side. I make one punch mark on one side, two punch marks on the other side.

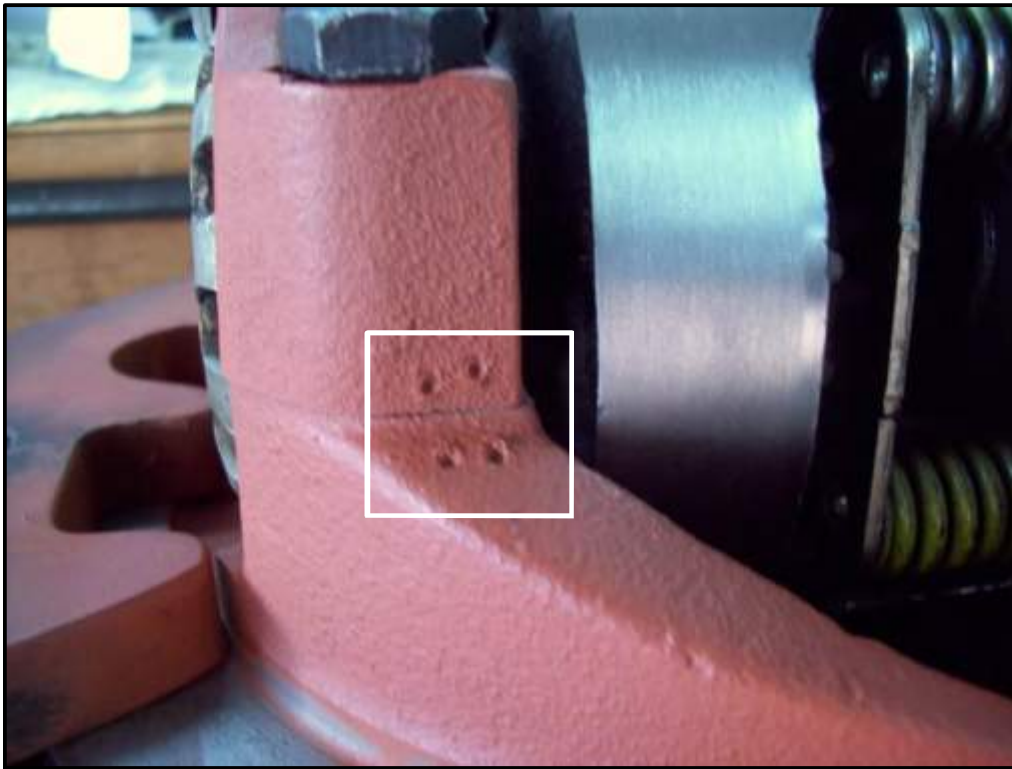

Again, the '56 rear-end manual is quite clear about how to set bearing preload and backlash. Here is my dial indicator showing **0.005 in** backlash in two different locations. **The ideal range is 0.005-0.008.**



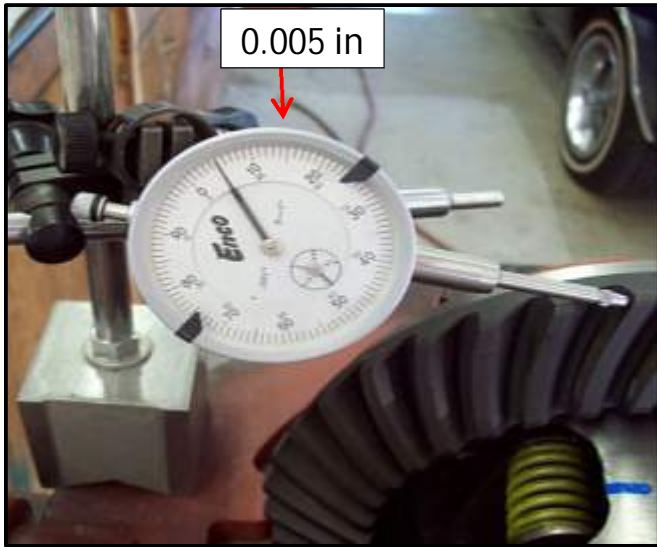

Once the backlash and carrier bearing preload are established, I check the tooth-contact pattern with white marking compound brushed on BOTH sides of 4-5 teeth.

Also, the '56 rear-end manual is quite clear about how to apply pressure on the gears to obtain a pattern. The pattern below was ultimately achieved with a 0.031 pinion shim. This is NOT the perfect pattern, but it was the best I could achieve and the **MOST DESIRABLE PATTERN IS ON THE DRIVE** side of the teeth, which is what I ended up with here. By changing to a thinner shim, to get the drive side pattern deeper, it makes toe coast pattern go further than desirable in the opposite direction. So, this is what I got.

UNDERSTAND, YOU MAY NOT ALWAYS GET A PATTERN AS SHOWN IN THE ILLUSTRATIONS OF CONTACT PATTERNS. Thus, you just have to go with the **BEST** pattern that can be achieved. Also, with **USED** gears, this is the **ONLY** way to get an optimal pattern. Of course, this may (and probably will) require tearing down the rear 2-3-4-5 times, pressing off and on the pinion bearing to change shims until you end up with an acceptable pattern.



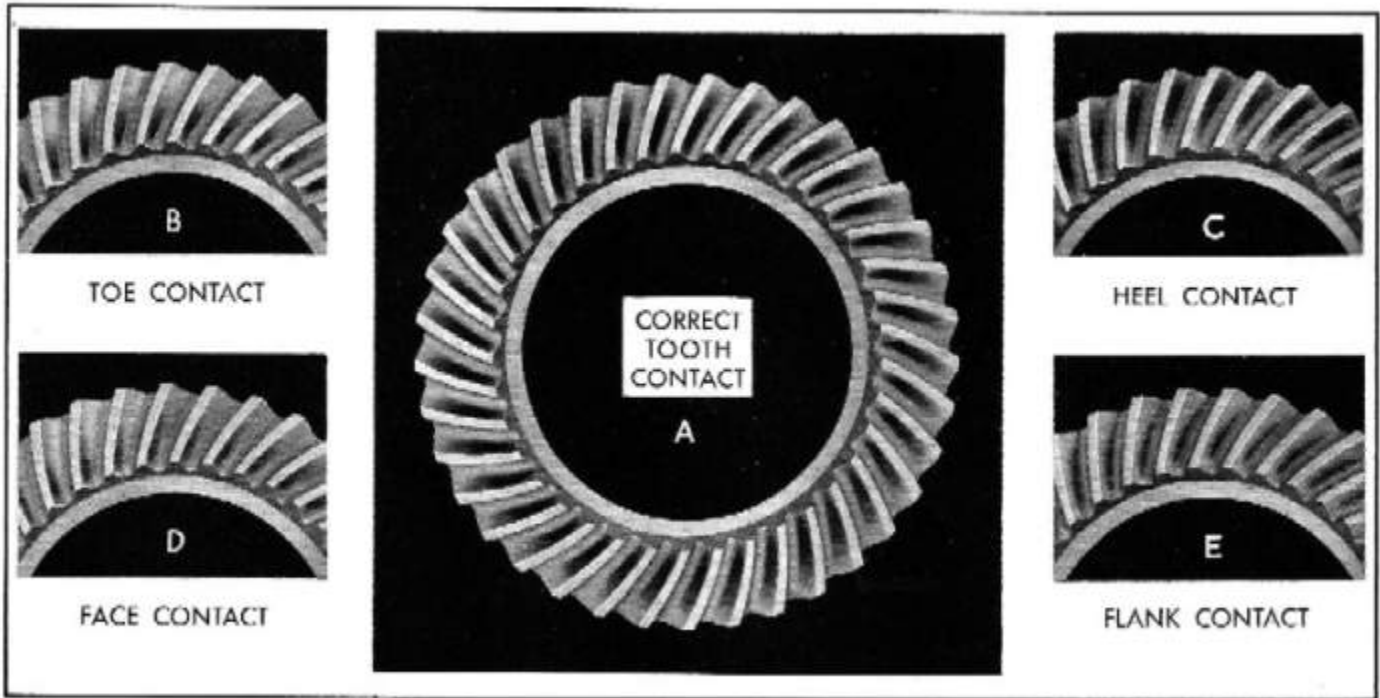
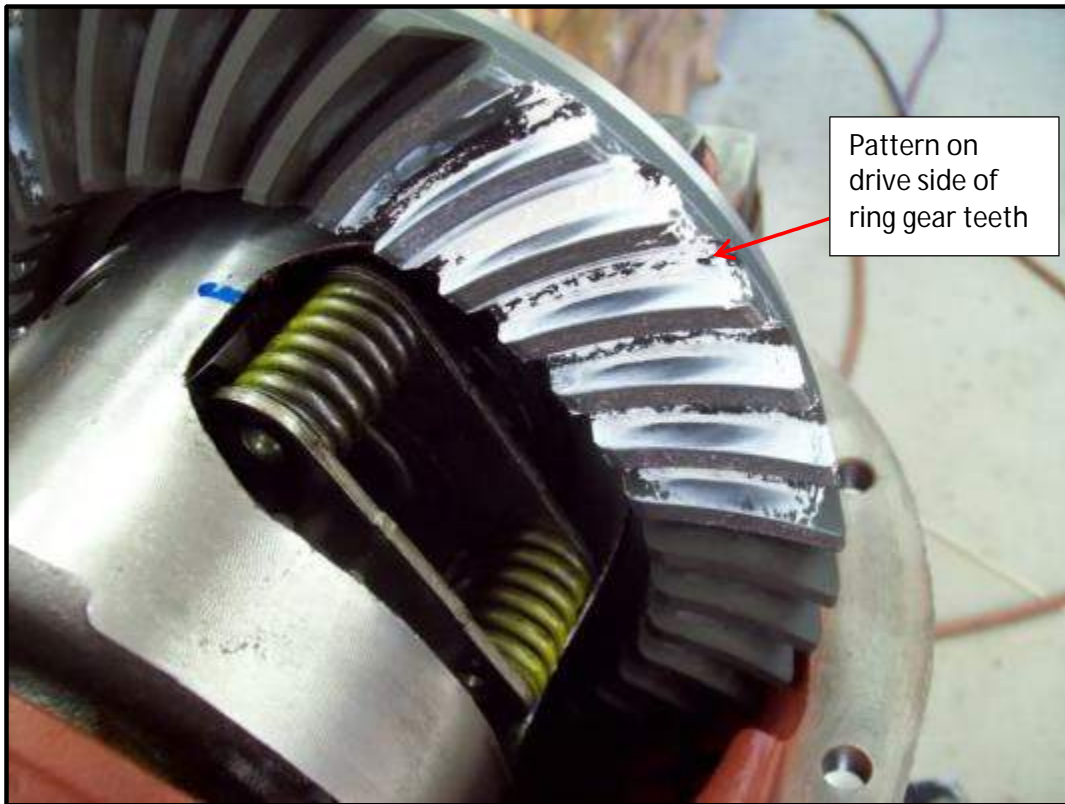

Fig. 49—Gear Teeth Contact Patterns

Illustration from page 30 of Servicing the 1956 Passenger Car Rear Axle

Once all adjustments and setup are complete, remove the nut, washer and yoke and install the new pinion seal. I like to use a VERY light coating of gasket sealer around the seal before carefully tapping it into the case.



Before putting the yoke back on, I THOROUGHLY clean the splines of the pinion and yoke and paint gasket sealer in the splines of the yoke to seal against any oil leaking through the splines. Put the yoke back on, then the washer and nut.



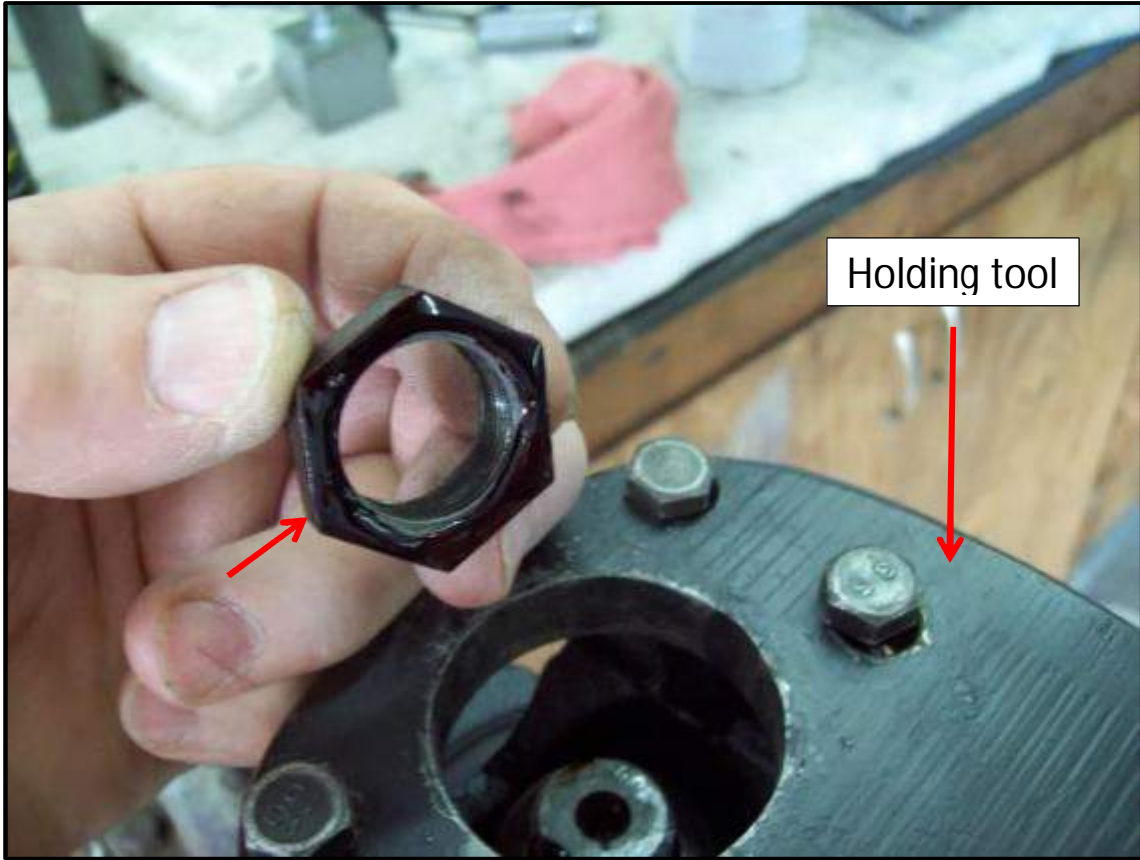

When I first setup the pinion with the new crush sleeve, **BEFORE installing the new seal**, I only tighten the nut to achieve about **20 in/lbs** preload on the pinion bearings. Once the seal is installed and the yoke, washer and nut are finally installed, I also use gasket sealer on the washer and nut, then finish tightening the pinion nut to achieve the **25 in/lbs** specified in the rear-end manual.

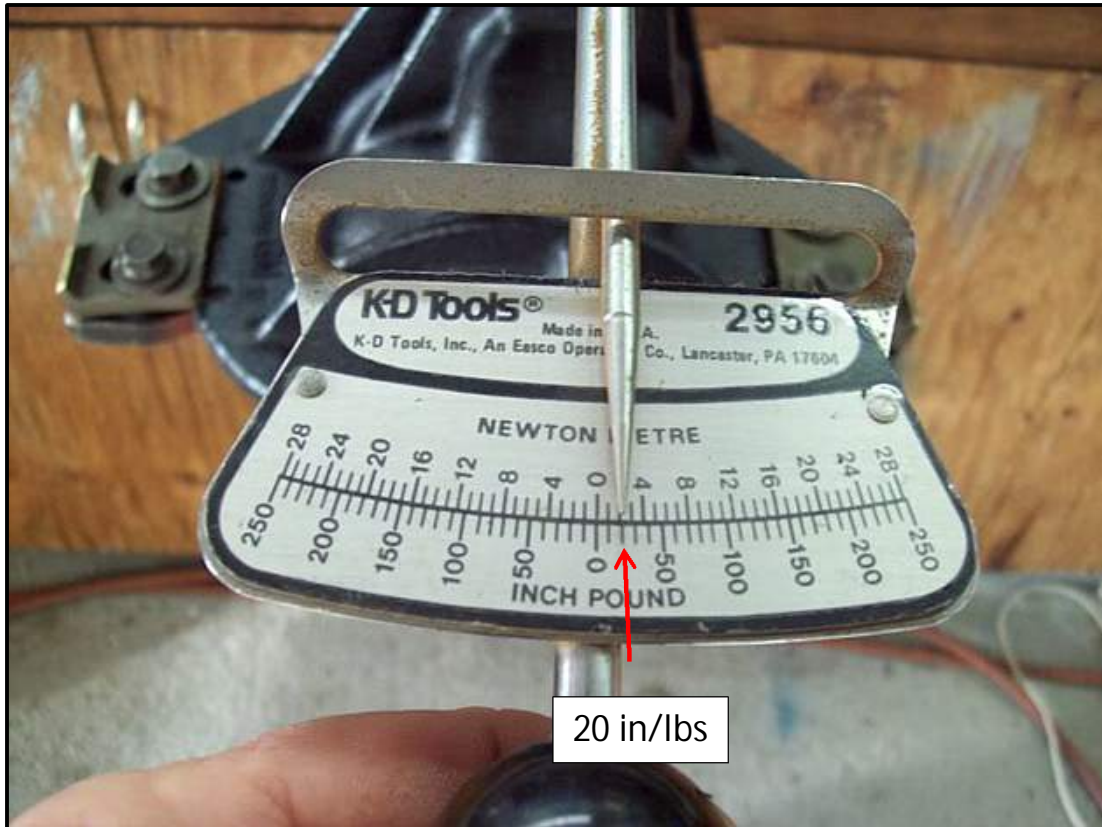

Finally finished:



Tom Parsons

Here is an additional picture that I didn't include in the original information.

[\(http://www.chevytalk.org/fusionbb/showtopic.php?tid/223802/\)](http://www.chevytalk.org/fusionbb/showtopic.php?tid/223802/)

When rebuilding a **FACTORY** style positraction unit (made for GM by **DANA**), it is **VERY IMPORTANT** to have the splines of the 2-piece axle gears lined up **BEFORE** pulling the 2 case halves together with the 8 bolts. It is **TOOOOOOOO EASY** to do!

You need 2 axles to do this with, or the splined ends from 2 junk axles. Insert each axle end **ALLLLLLLLL** the way into both sides of the posi unit, **assuring that they go all the way through BOTH of the 2-piece axle gears**. I place an axle in the vice, and then insert the end of a junk axle in the other side of the posi unit and start tightening the bolts, finally torquing them to **45lbs**.

If the splines are not aligned when the posi unit is being reassembled, it may be VERY difficult to get the axles back into the axle housing because they cannot go into the splines of the second part of the axle gears.



Here is what the 2 parts of the axle gears look like when the axle splines are inserted into both parts.



Tom Parsons

The Nitro Power Lock Positraction Unit:

<http://www.chevytalk.org/fusionbb/showtopic.php?tid/223912/>

06-11-13 07:21 PM - [Post#2354374](#)

UPS delivered 2 Nitro Power Lock posi units today. Here is my assessment after inspecting one of the units.

At first glance, the Nitro posi unit looks like the original '60-'64 GM/DANA unit. However, there are some changes which, in my opinion, are very nice improvements. The Nitro units only come in a **3-series version**. To use it with 4.11-up gears, it will be necessary to either use thick ring gears, or, use a ring-gear spacer.

Here are two overall views of the Nitro unit:



Here is a comparison of the internal axle gears of the DANA (left) and the Nitro axle gears:

DANA

Nitro

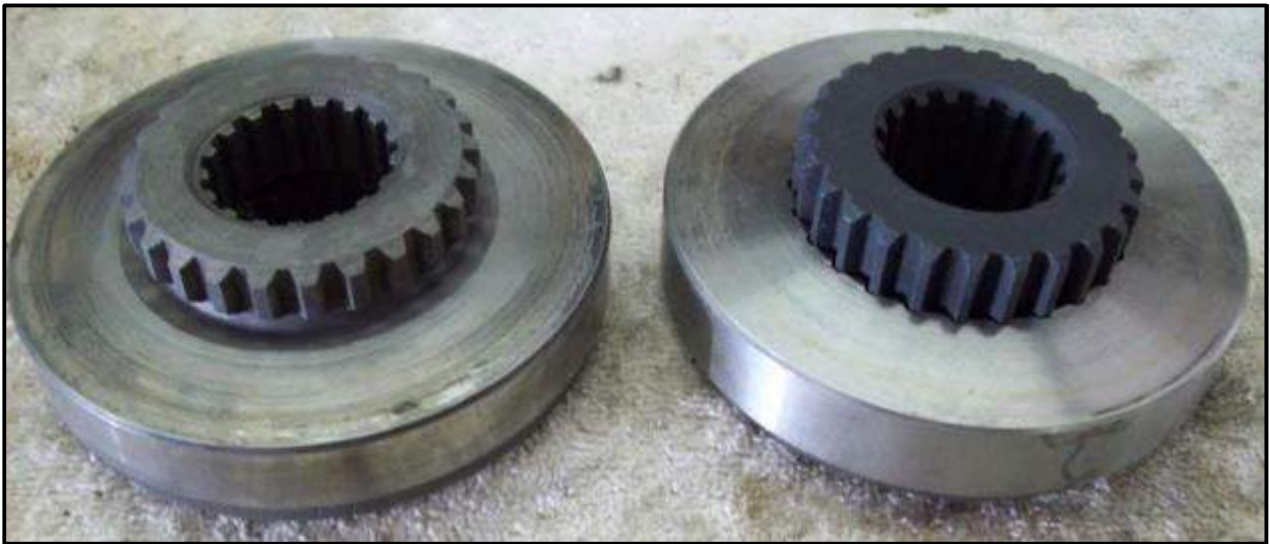



The axle gears of the original DANA unit are 2-piece whereas the Nitro axle gear is ONE piece. This is an improvement; PLUS, an added benefit is that it is not necessary to assure that each pair of axle-gear splines is lined up (as was described above).

The splines for the clutch plates are slightly longer on the Nitro axle gear. Another improvement!

All 10 (5 per side) clutch plates are the **THICK** versions (one Belleville per side). There are NO thin plates. What this means is that the clutch plate pocket on each half of the unit must be machined slightly deeper (maybe about 0.030in per side??). I like the idea of all plates being the same thickness.

The bolts are **RIGHT-HAND FINE-THREAD** (grade 8), as opposed to left-hand threads on the original DANA units. **The benefit is that it will be much easier to obtain regular grade 8 fine thread bolts if replacement is needed.**

Below is the Nitro unit separated to show its internal parts.



Five clutch plates of equal thickness.



There is ONE very minor down-side, but to me it's a non-issue. If this unit is used in a '55 -'56 -'57 axle housing along with '55 -'56 -'57 axles, **then it will STILL be necessary to cut off 1/8 inch from the splined end of each axle.**

The price of the Nitro unit is comparable to the Eaton unit, however, if you are installing an Eaton posi unit in a '55 -'57 axle housing, it won't be necessary to trim the axles.

Is this a better unit than an Eaton? I don't have an opinion. BUUUUUUUUUUUUT, I like the design of the one-piece Eaton case. In the past, I have seen DANA posi units with all 8 bolts sheared.

The internal parts/gears of the Nitro unit can be purchased separately, which is good, and they can also be used to upgrade an original '60-'64 DANA unit.

Tom Parsons

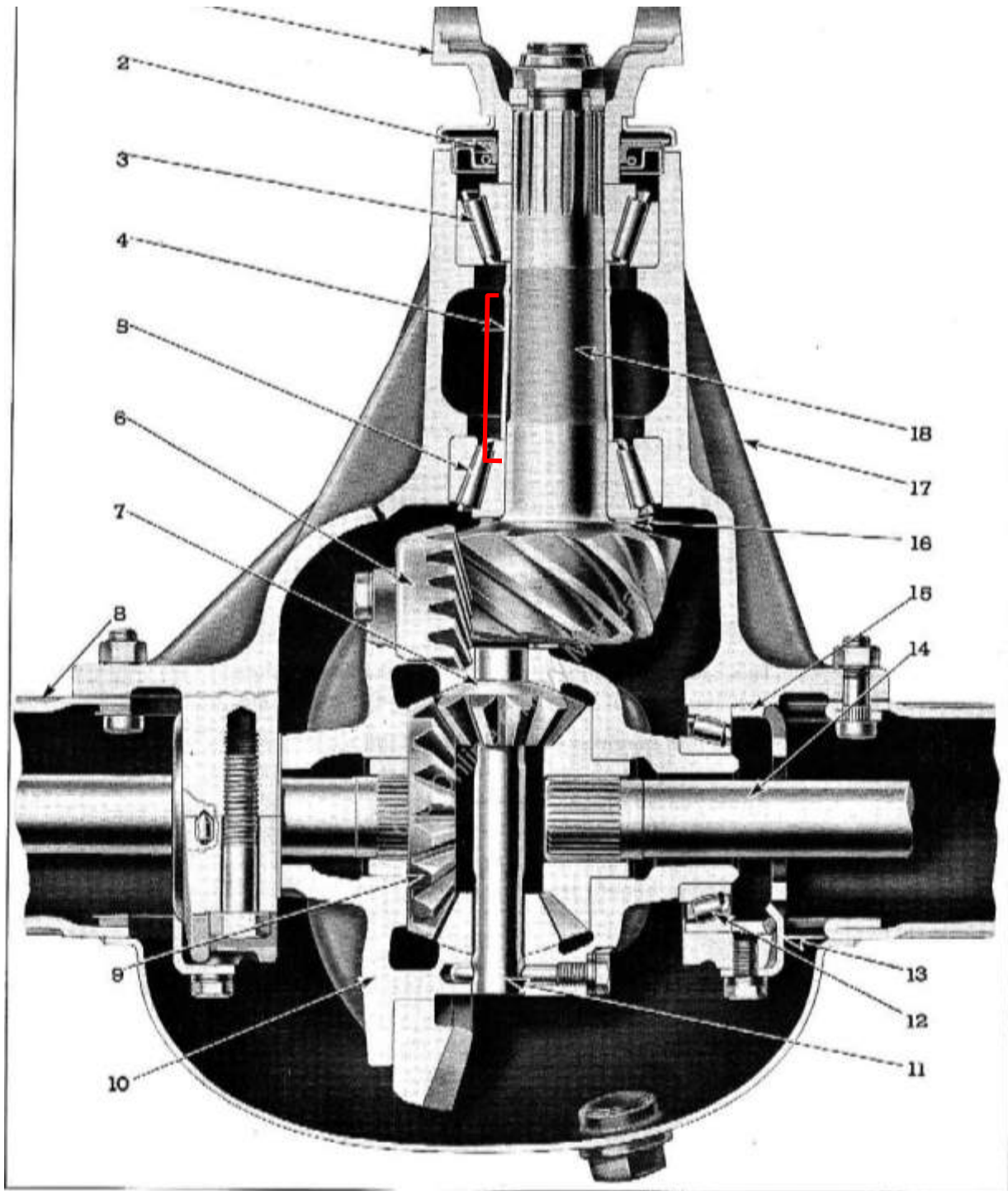

Fig. 1—Differential Carrier Assembly

- | | | |
|------------------------------|-------------------------------|--|
| 1. Companion Flange | 7. Differential Pinion Gear | 13. Differential Side Bearing Adjusting Nut Lock |
| 2. Companion Flange Oil Seal | 8. Axle Housing | 14. Axle Shaft |
| 3. Front Pinion Bearing | 9. Differential Side Gear | 15. Differential Side Bearing Adjusting Nut |
| 4. Pinion Bearing Spacer | 10. Differential Case | 16. Pinion Depth Adjusting Shim |
| 5. Rear Pinion Bearing | 11. Differential Pinion Shaft | 17. Differential Carrier |
| 6. Ring Gear | 12. Differential Side Bearing | 18. Pinion Gear |