

# Wiring and Bench Testing an Assembled Mid-Year ('63-'67) Corvette Instrument Cluster

Dave Zuberer and Tim Welsh  
May 2016



The information/procedures presented here are based on work done by Tim Welsh (a.k.a. “buns” on the Corvette Forum (C1-C2) working on his '66 and some earlier work by DZ during the rewiring and refurbishment of the dash in his '65 coupe. As Tim points out multiple times throughout the document, the colors of the various connecting wires may be different according to the different production years thus one must pay close attention to the wiring diagrams for his/her particular year of manufacture. We have made all attempts to show the correct colors for the various model years.

We appreciate the help of John Hinckley and Rich Mozzetta in reviewing this document for us and for allowing us to use selected photos!

The starting point for this presentation assumes one is starting out with **fully functional gauges** and perhaps even a new dash harness.

**For convenience, the diagrams and illustrations that follow are arranged in the order you would see them looking from the left side to the right side of the instrument cluster.**

**Note:** most of the wiring diagrams shown here are based on those from **GM Assembly Instruction Manuals** (“AIMs” or the shop manuals) for the mid-year Corvettes and a few are based on diagrams from the Mitchell Repair Information Company. Lamp harness and bulkhead connections from the GM diagrams are included at the end.

**CAVEAT: WHILE WE HAVE ATTEMPTED TO VERIFY ALL THE CONNECTIONS AND WIRE COLORS DEPICTED HERE, YOU SHOULD RELY ON THE DIAGRAM THAT COMES WITH YOUR HARNESS.**

## Locations of the Mid-Year Corvette Gauges and Switches in the Instrument "Cluster"

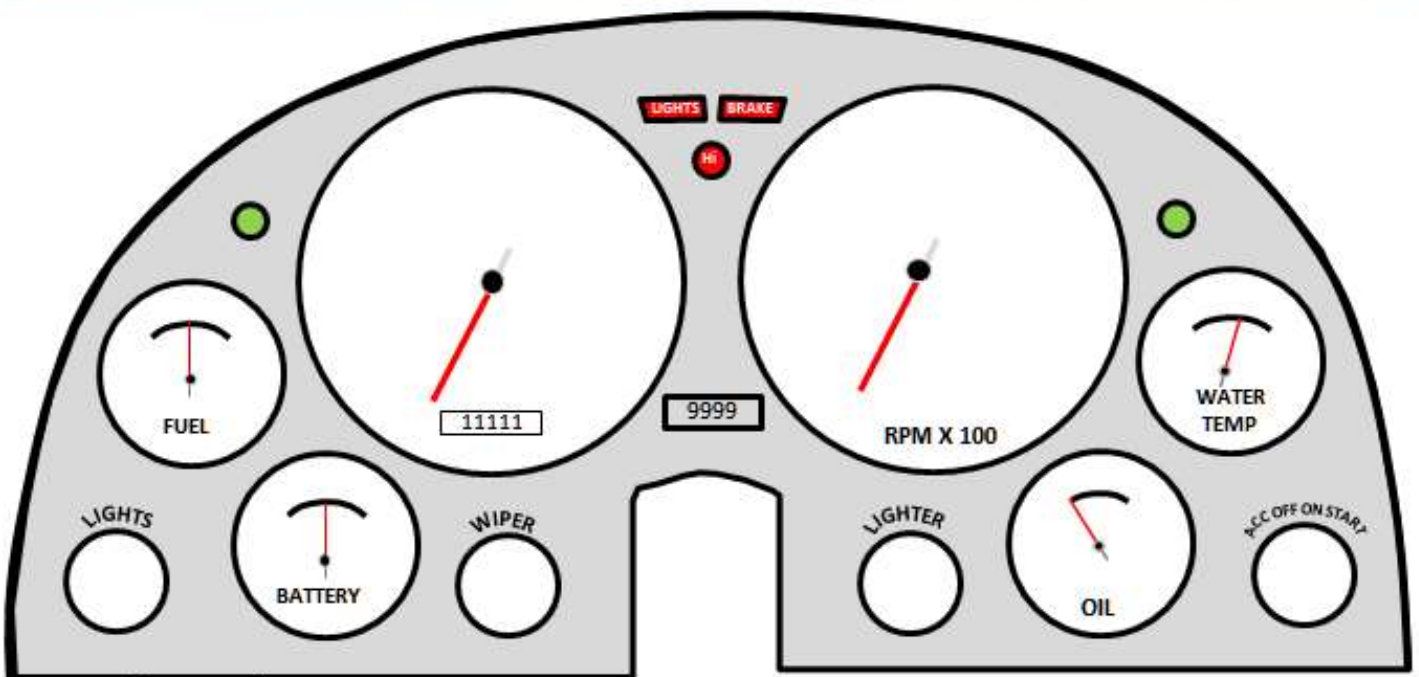

Headlight  
bucket rollover



## Powering Up the Cluster on the Bench:

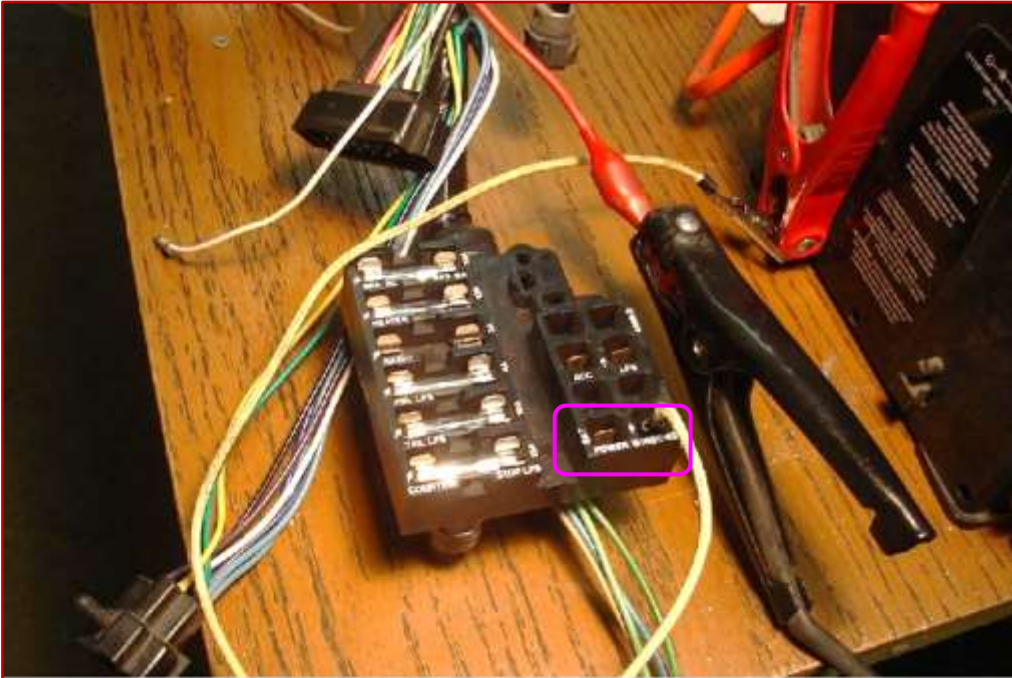

To "power up" the gauge cluster, put 12 Volts positive to the "Bat-Power Windows" terminal on the fuse block. Then ground the cluster. You will be able to test everything except the Battery and Oil gauges.

To power up the cluster on the bench, hook the **negative 12V source to the spade lug cluster ground** (above the tach) and the **positive 12V to one of the lugs for the BAT. POWER WINDOWS** in the fuse panel. If all is well, the cluster should light up as below. ***"It is wise to include a 30-amp circuit breaker between the 12V power source and the connection to the new dash harness."*** This protects all non-fused circuits, and as is well known, the pre-1967 main harness has no Fusible Link protection. If something was in fact wired wrong, or a defective harness was in place, the CB would help keep the harness from burning up." (Tip from Rich Mozzetta)

[Link to YouTube video](#)

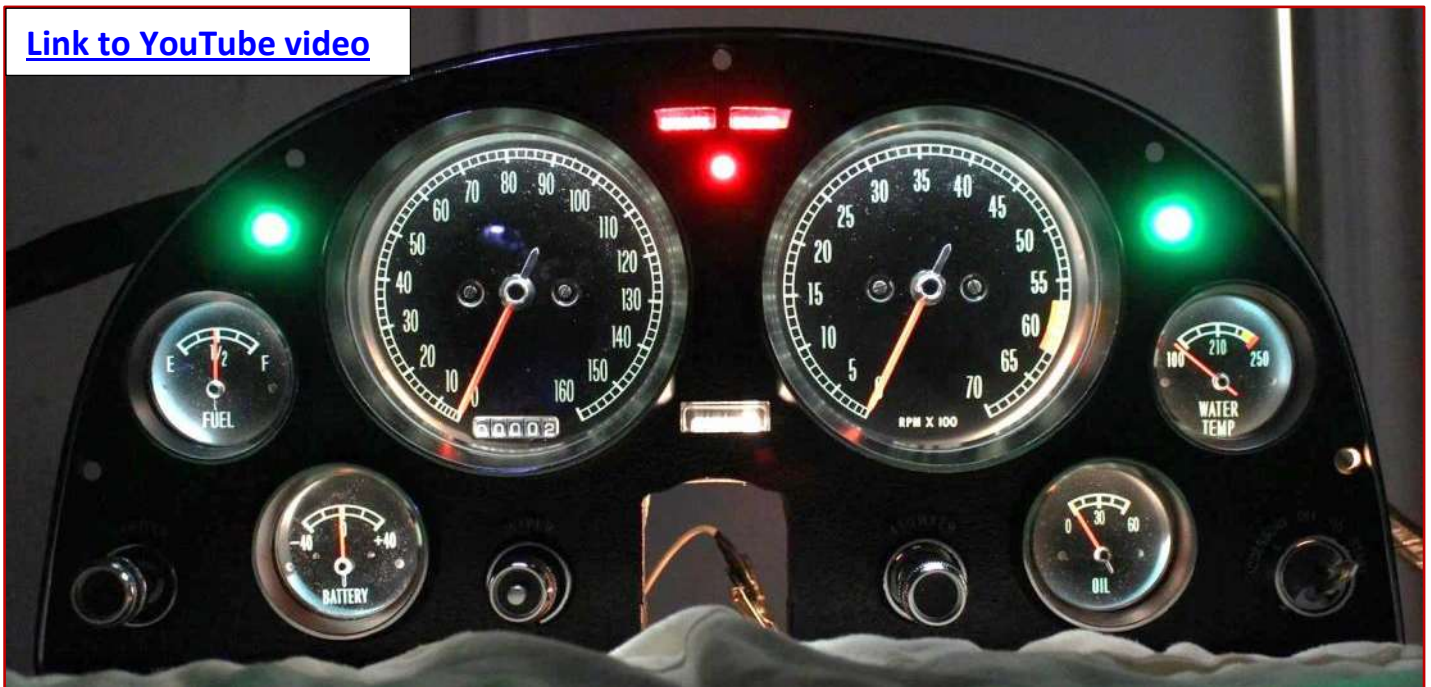

# Mid-Year Corvette Light Switch Wiring

## Mid-Year Corvette Light Switch Wiring

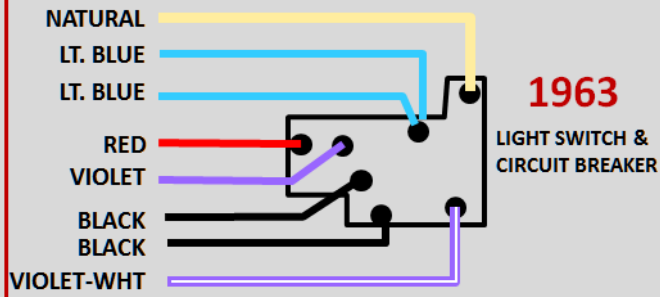

## Mid-Year Corvette Light Switch Wiring '66-'67

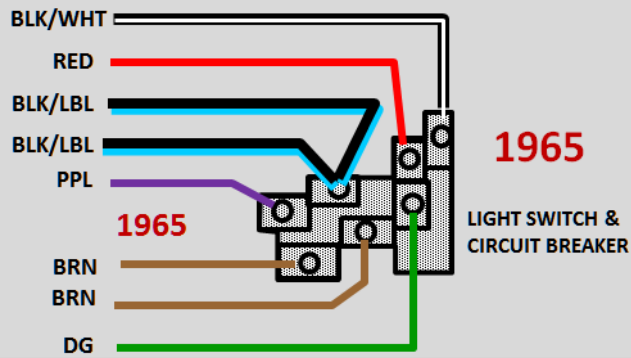
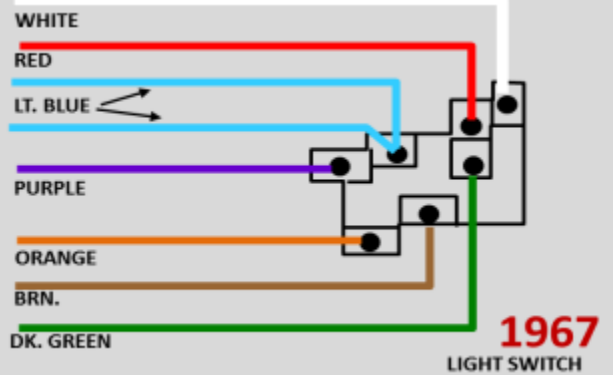
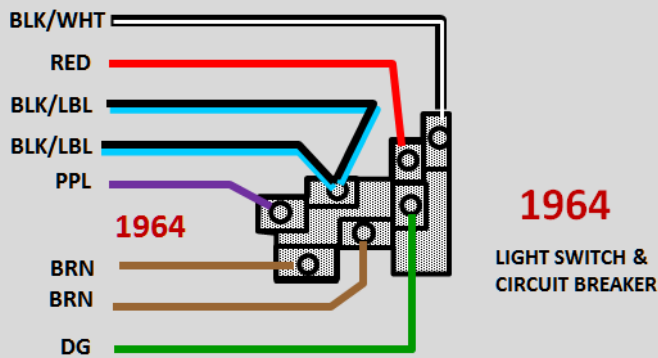
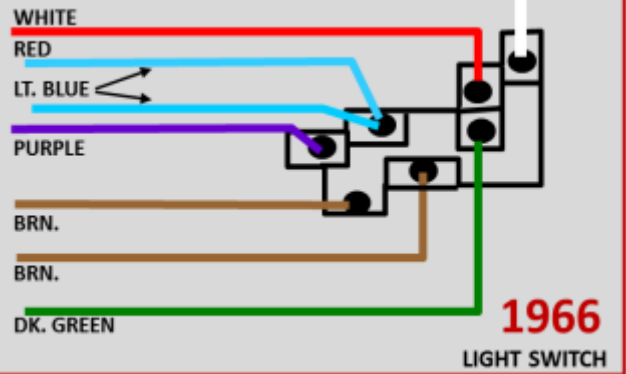



## Fuel Gauge and Sender Connections:

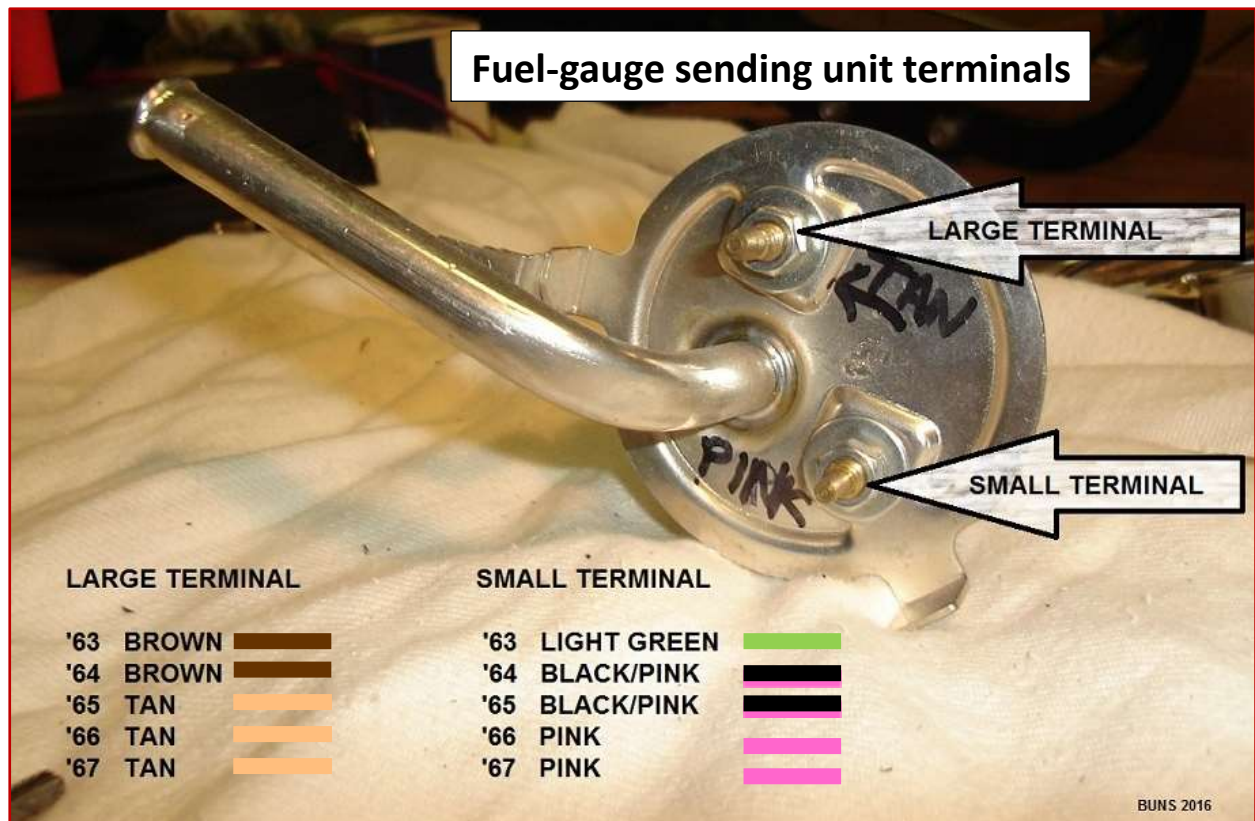
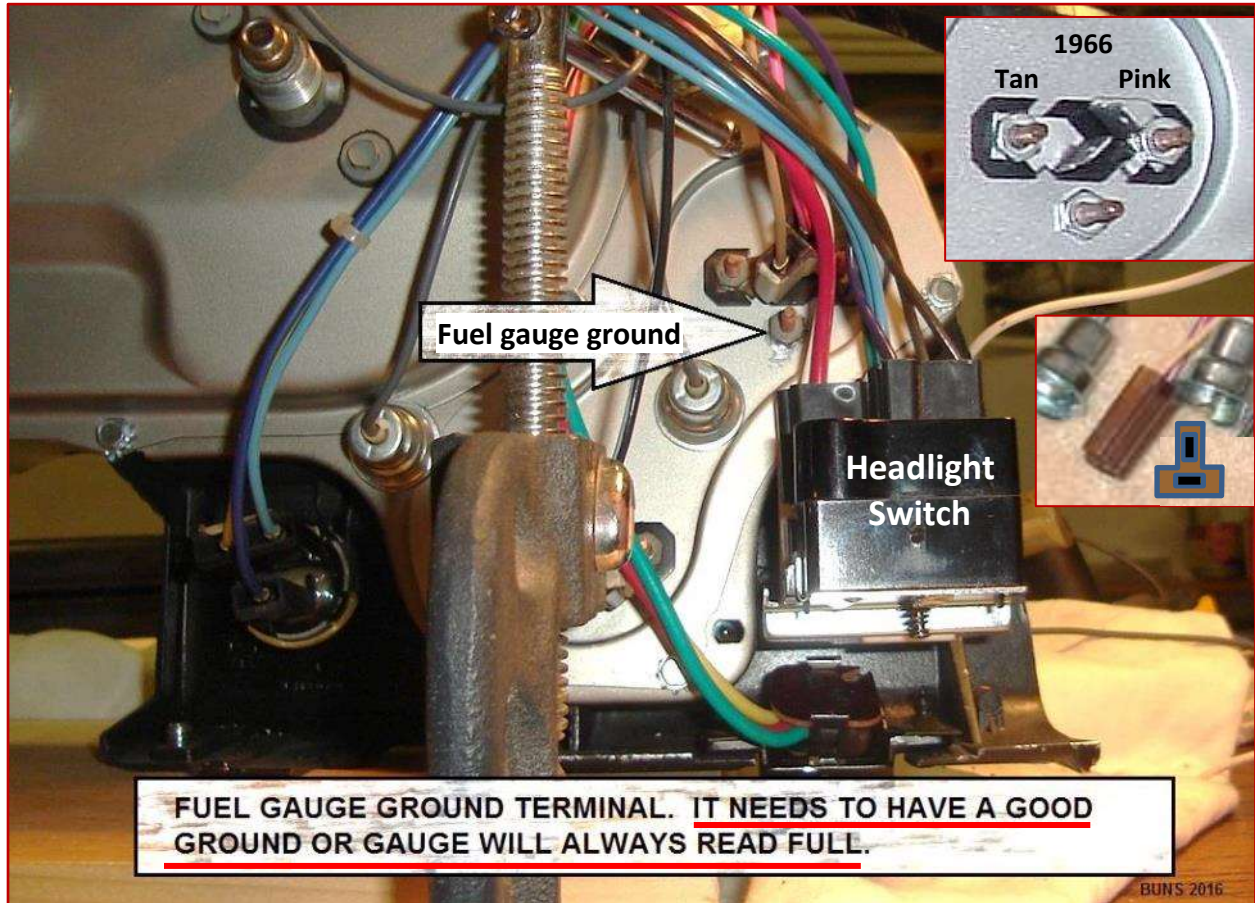

# '63 to '67 Corvette Fuel Gauge Bench Test

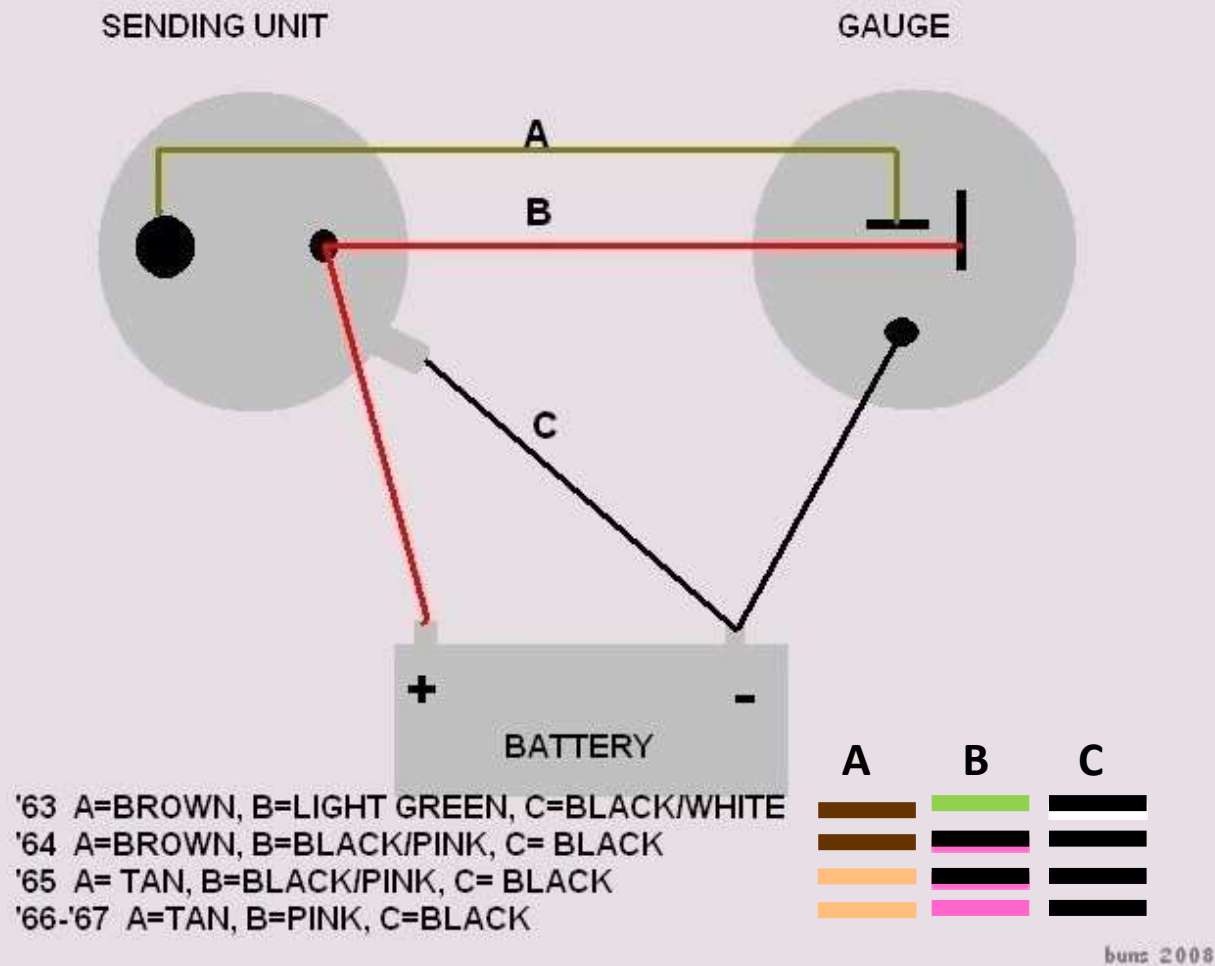

If the gauge is mounted in the cluster and the wiring terminal is attached, you won't have to run power to it, just turn the ignition switch on.



## Mid-Year Corvette Gas Gauge Sending Unit and Gauge Wire Colors

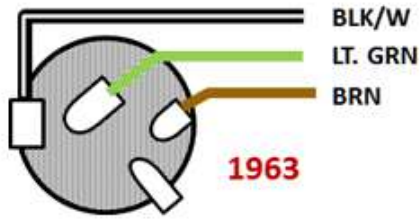

GAS GAUGE (TANK UNIT)



GAS GAUGE (DASH UNIT)

1963

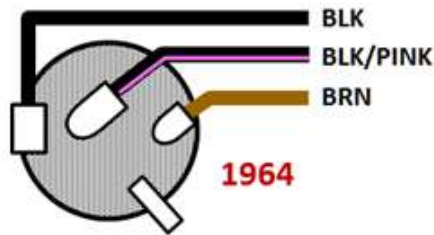

GAS GAUGE (TANK UNIT)



GAS GAUGE (DASH UNIT)

1964

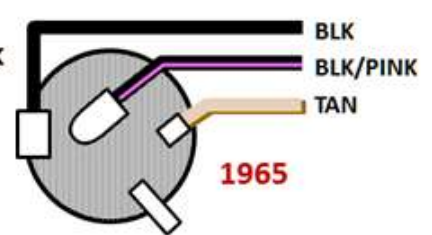

GAS GAUGE (TANK UNIT)



GAS GAUGE (DASH UNIT)

1965

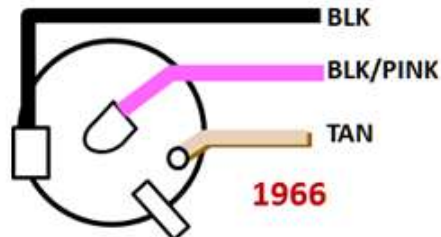

GAS GAUGE (TANK UNIT)



GAS GAUGE (DASH UNIT)

1966

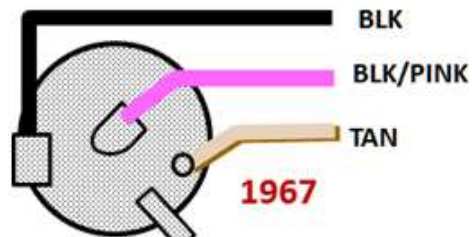

GAS GAUGE (TANK UNIT)

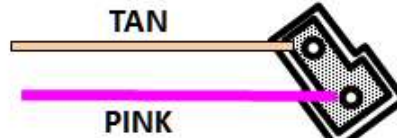

GAS GAUGE (DASH UNIT)

1967



S is the large terminal and I is the small one

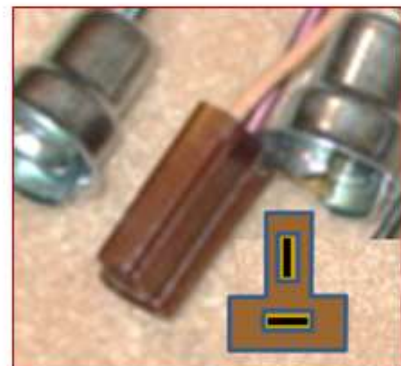



## Testing the Headlight Bucket "TELLTALE" bulb.

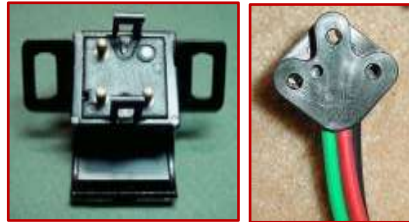

GROUND THE TERMINAL SHOWN BY THE ARROW TO TEST YOUR HEADLIGHT BUCKET "TELLTALE" BULB. HEADLIGHT SWITCH MUST BE ON. THIS IS A GREY/BLACK WIRE IN 1966. OTHER YEARS MAY BE DIFFERENT LOCATION, COLOUR.

The bulb for this socket is a #257 that blinks when the circuit is activated, i.e., the lights are on with the buckets not raised.

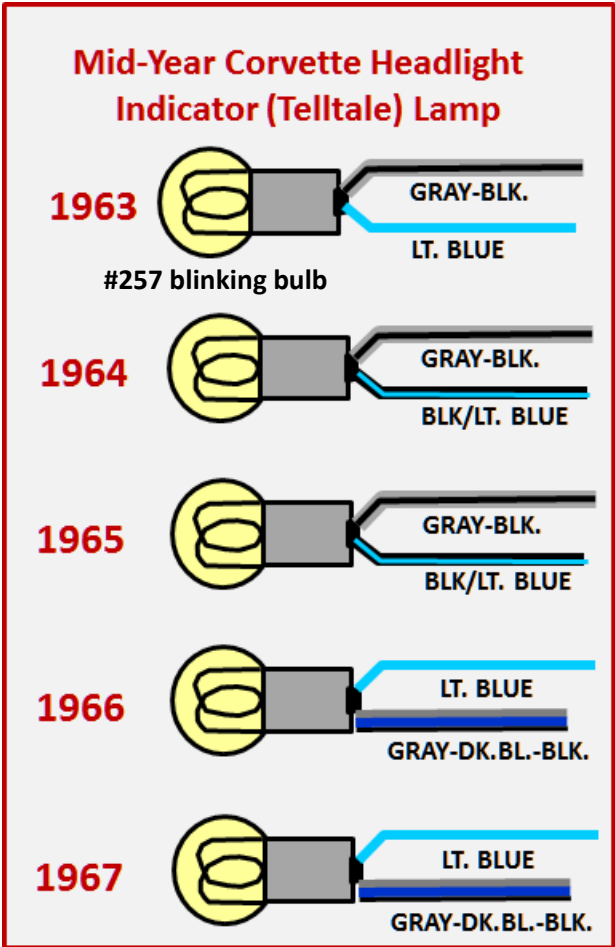
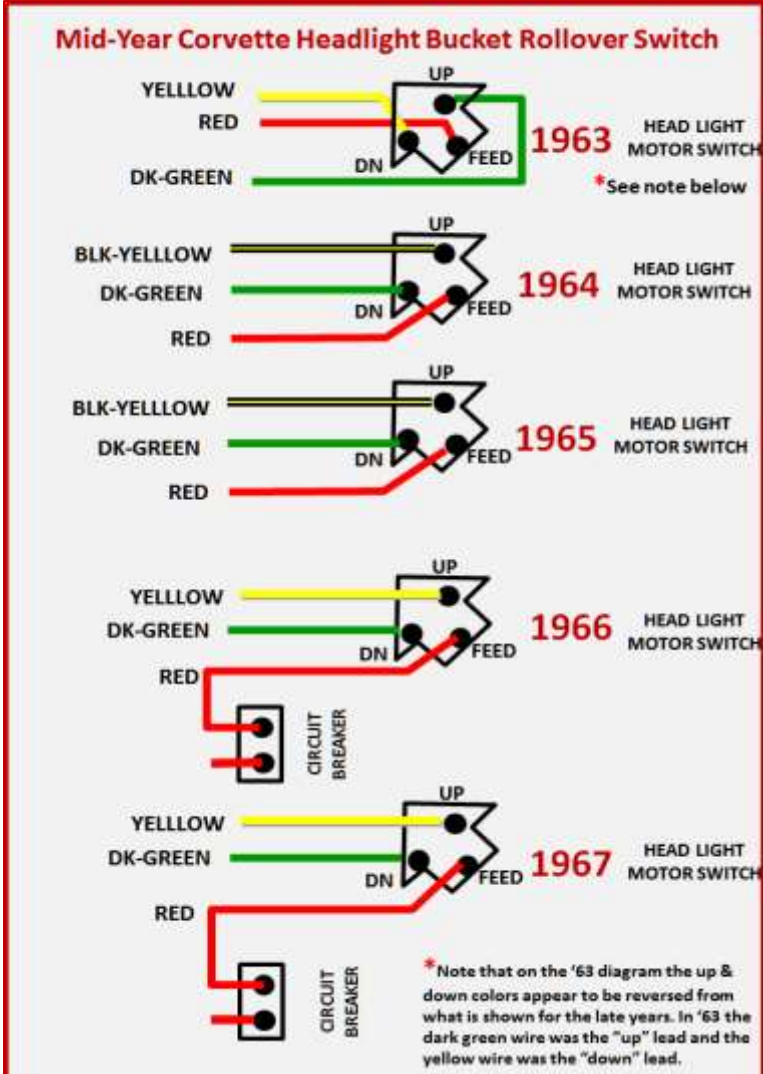



## Testing the headlight bucket “roll-over” switch:

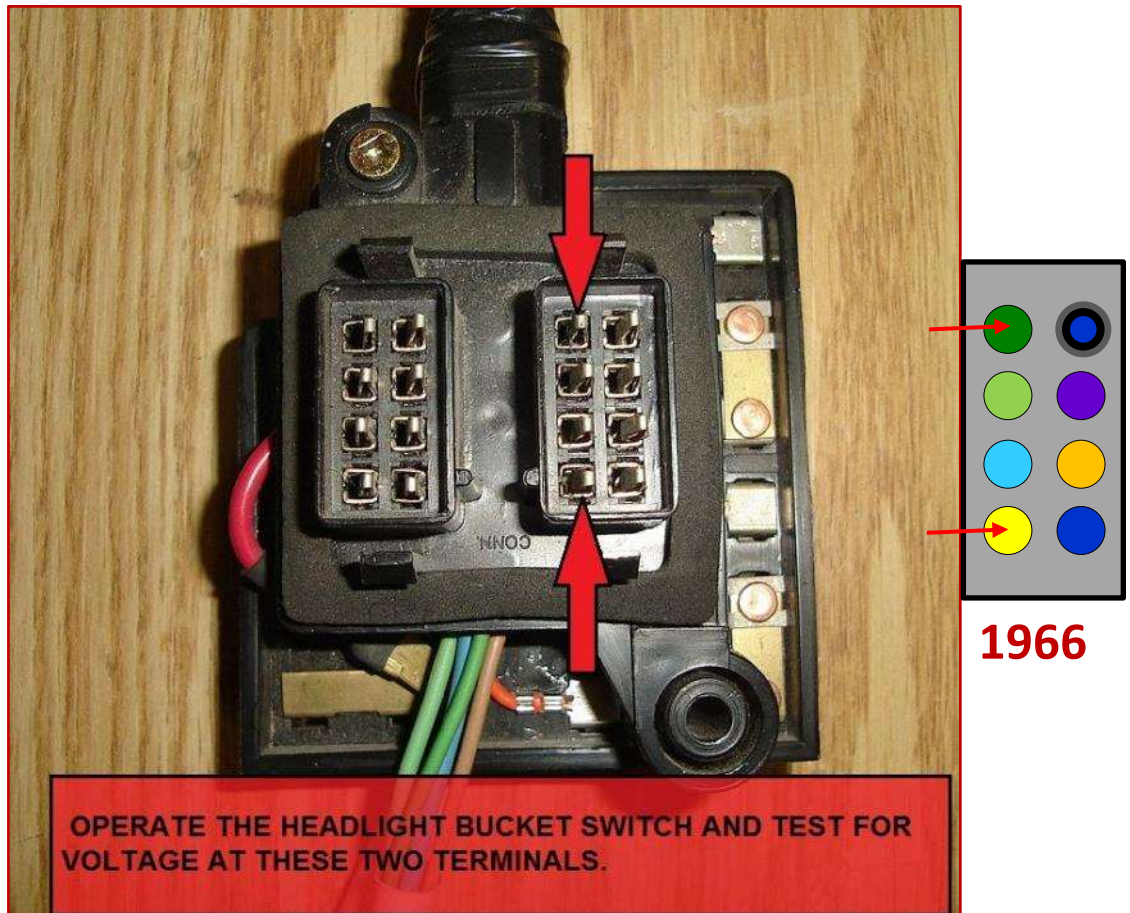
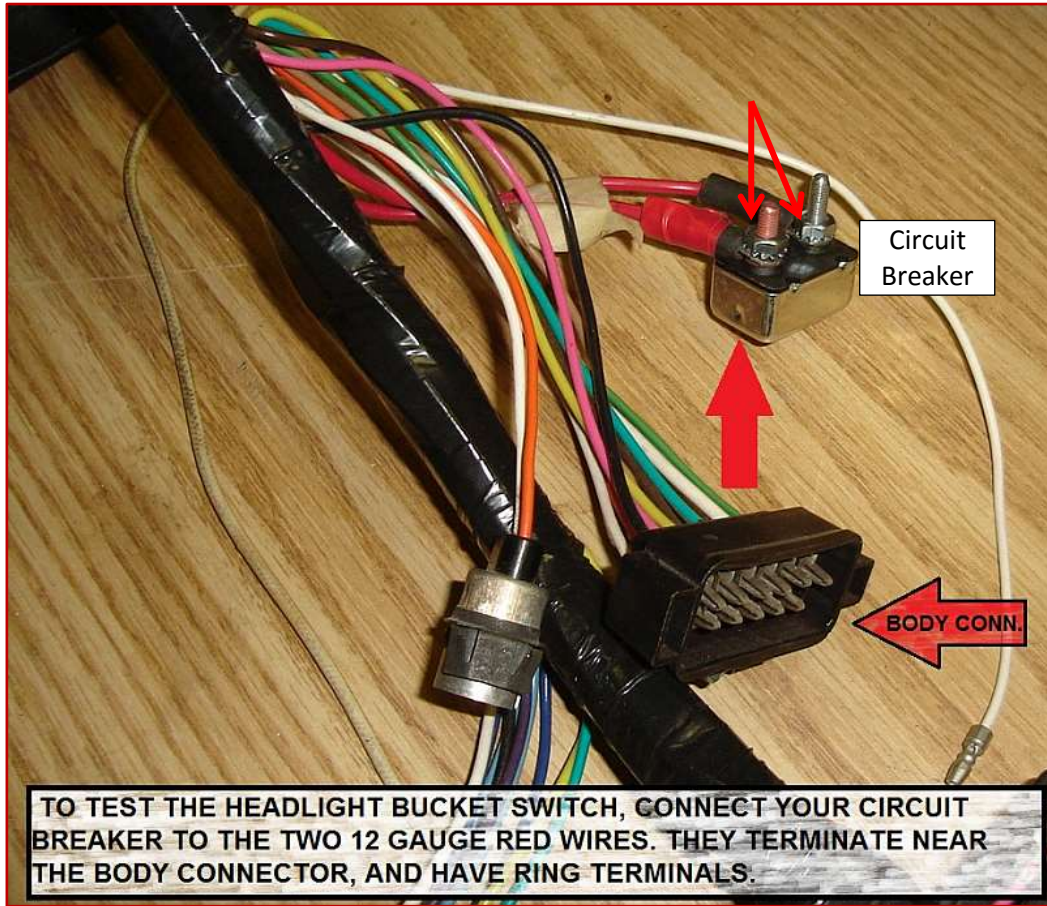



# Battery Gauge Wiring - '63-'67

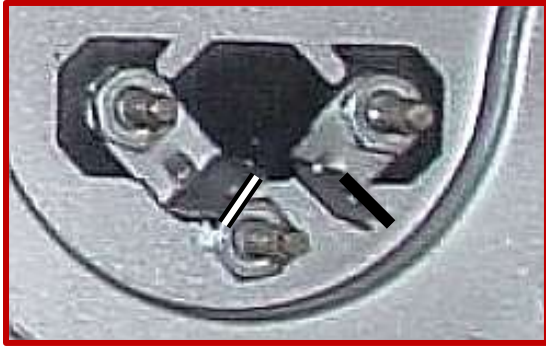

"Vee-shaped"  
two-terminal conn.

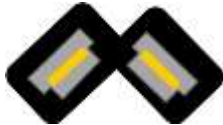
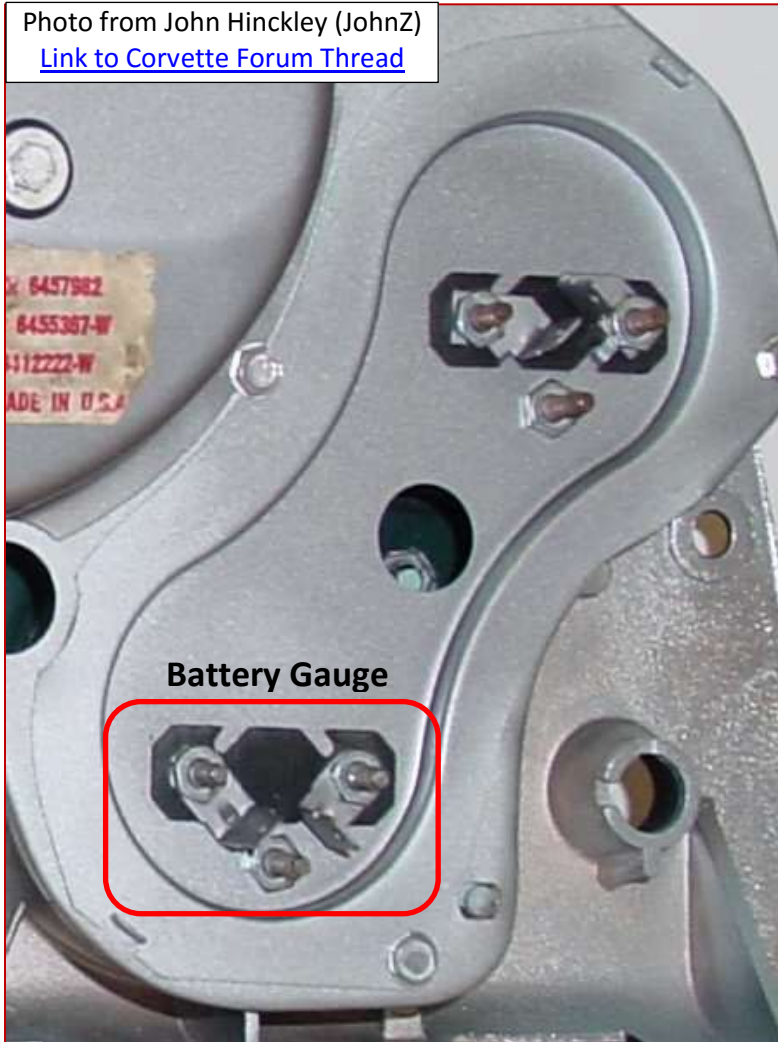
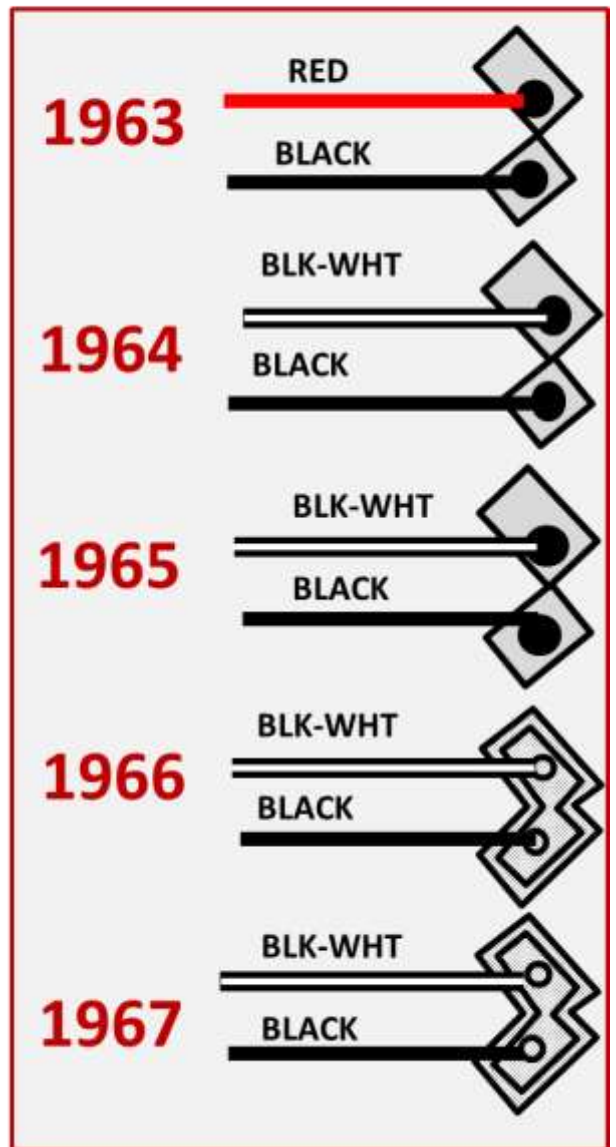

Photo from John Hinckley (JohnZ)  
[Link to Corvette Forum Thread](#)



Battery Gauge

## Mid-Year Corvette Battery Gauge Wiring





## Mid-Year Corvette Directional Signal Wiring

(These diagrams are the Mitchell Repair Information Co. format.)

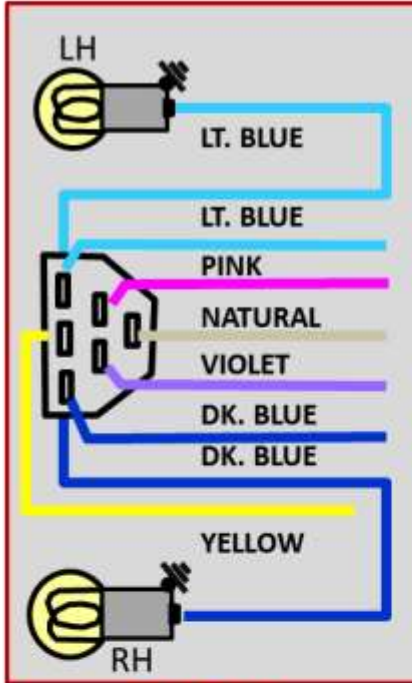

**1963**

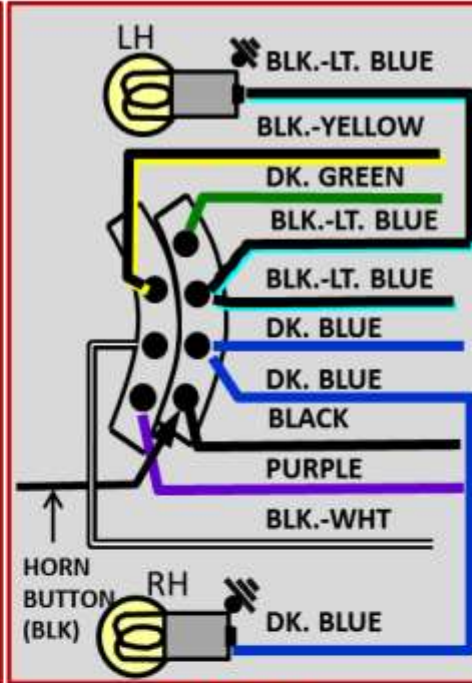

**1964**

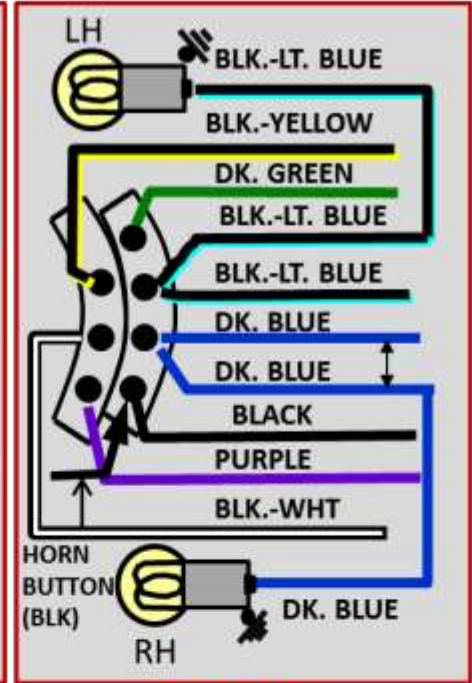

**1965**

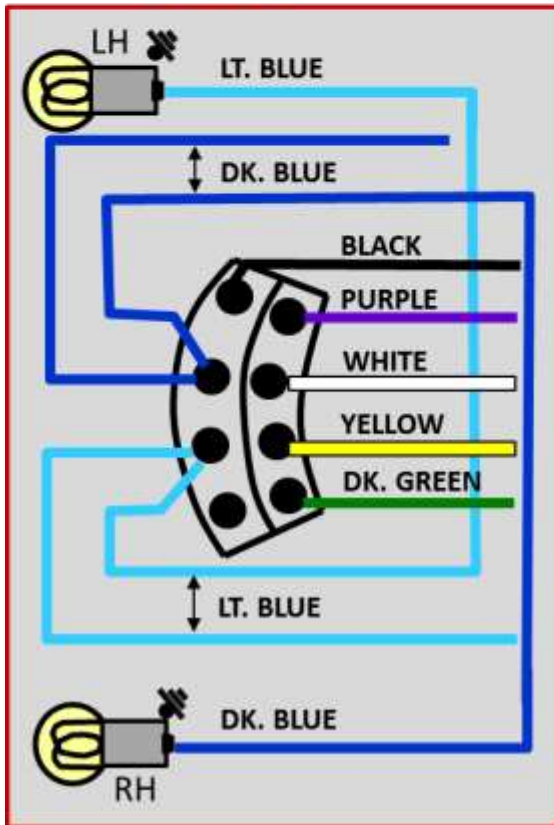

**1966**

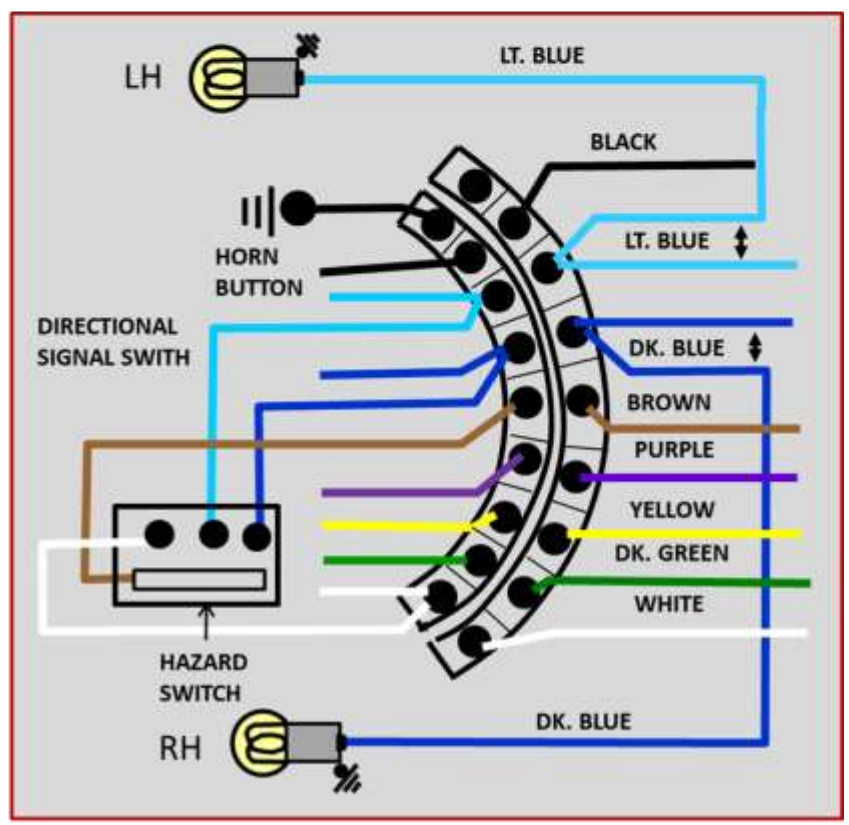

**1967**

The diagrams above are from the Mitchell Repair Information Company, NOT the GM AIMS. See next page for a comparison the 1967 GM AIM diagram vs. the Mitchell Repair Info. Co. diagram.

**A COMPARISON OF THE MITCHELL REPAIR INFORMATION CO.® DIAGRAM WITH THE DIAGRAM FROM THE 1967 GM ASSEMBLY INSTRUCTION MANUAL (A.I.M.)**

MITCHELL REPAIR INFORMATION COMPANY DIAGRAM

**1967  
"HARMONICA  
CONNECTORS  
MOUNTED ON  
STEERING  
COLUMN**

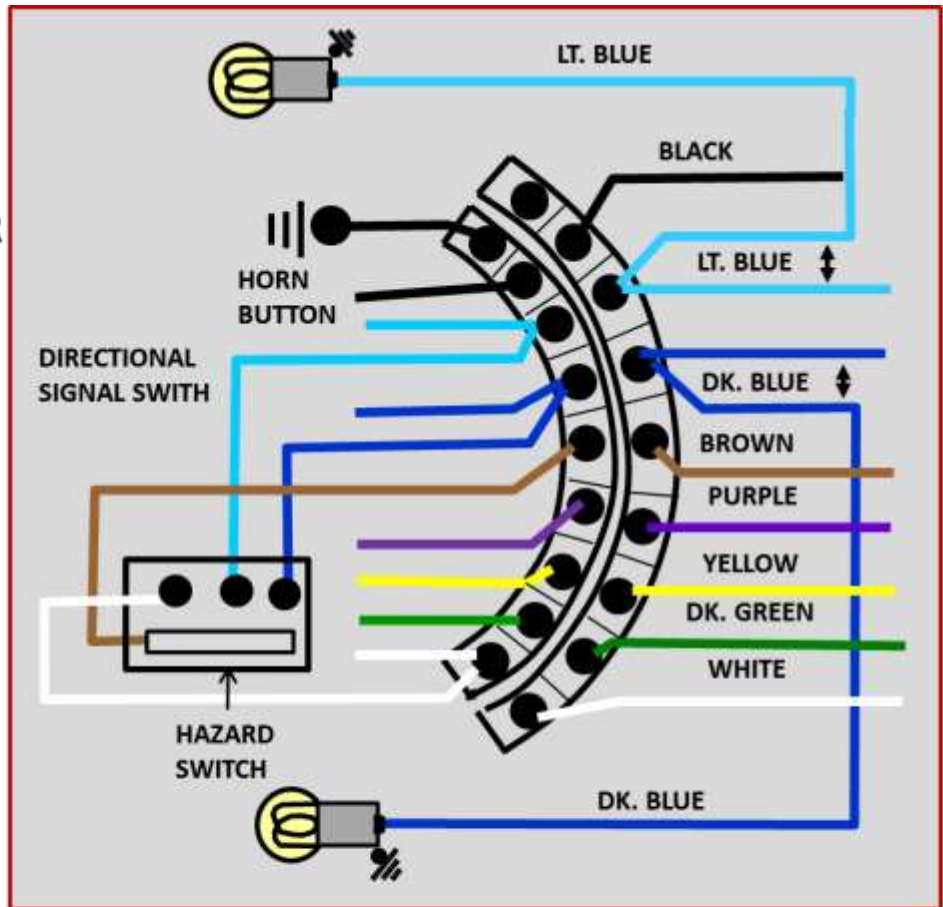

1967 GM ASSEMBLY INFORMATION MANUAL

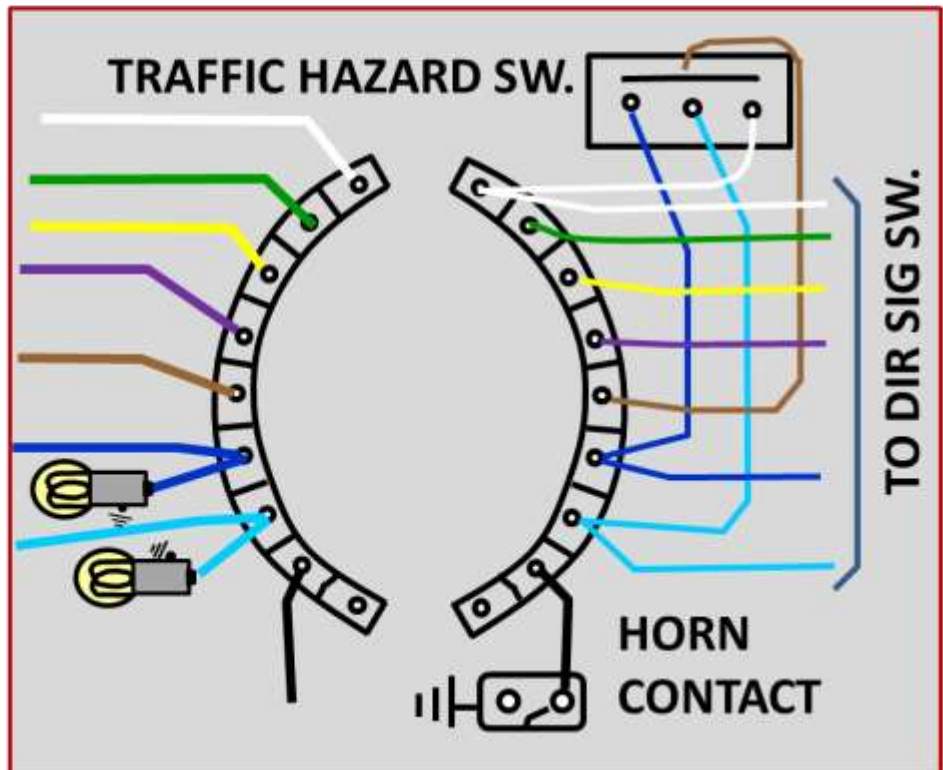



## Testing the cluster directional-signal lamps.

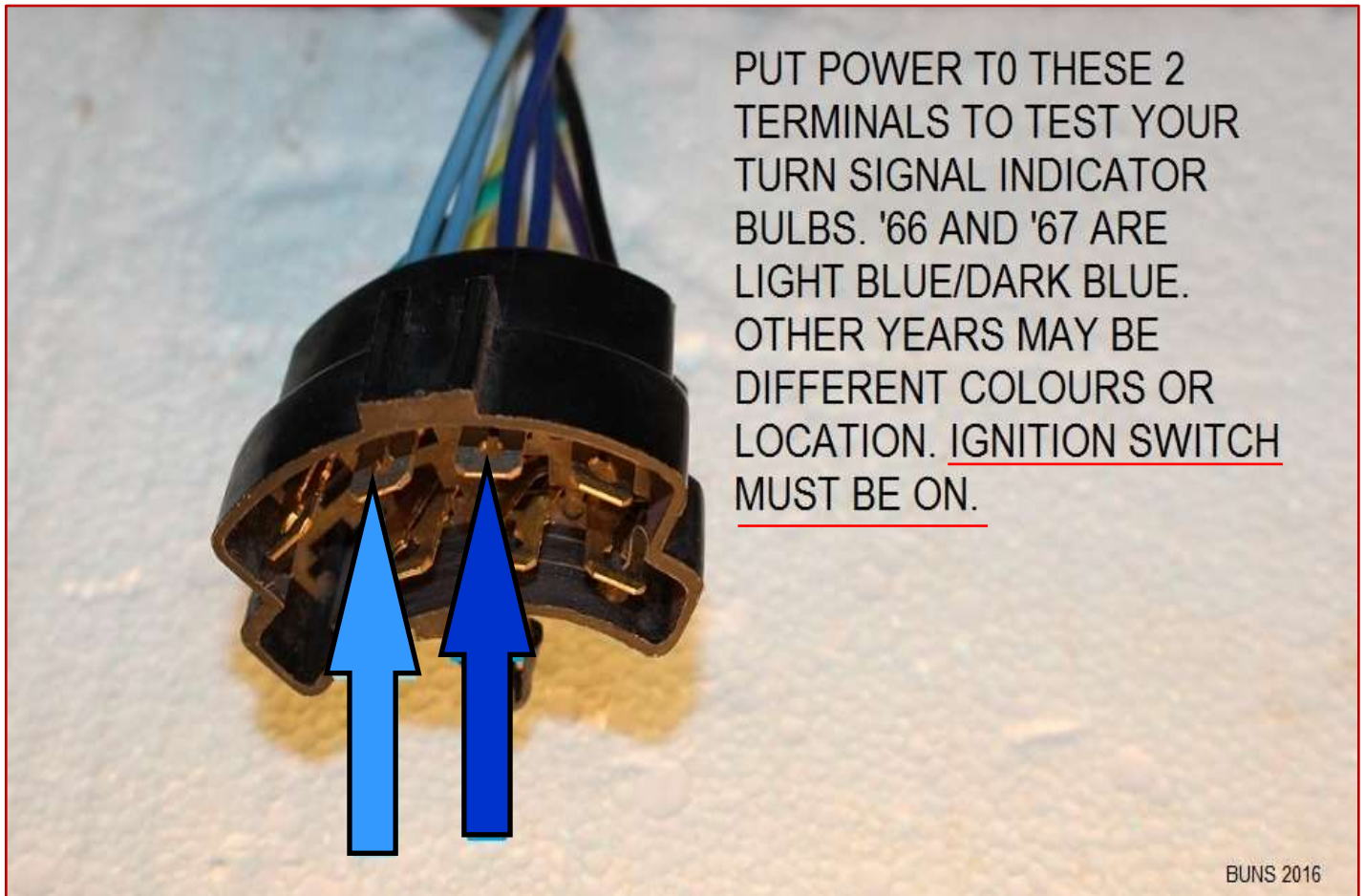

**The wires to the right side (psgr) turn signal indicator lamp are dark blue for all mid-year Corvettes.**

**The wires to the left side (driver) turn signal indicator lamp are light blue for years 1963, 1966 and 1967; they are black with a light blue tracer for the 1964 and 1965 model years.**

**See the diagrams above for the respective directional signal wiring schemes.**

## Mid-Year Corvette Headlight-Dimmer Switch and High-Beam Indicator Lamp Connections

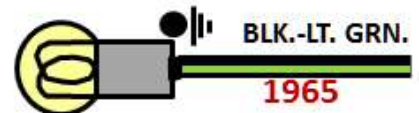
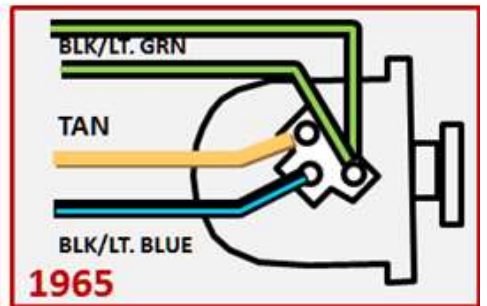
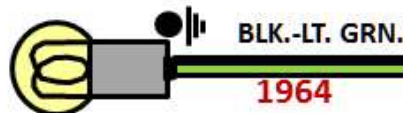
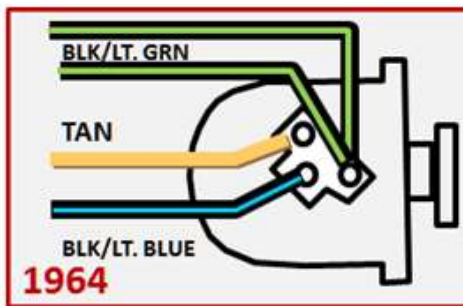
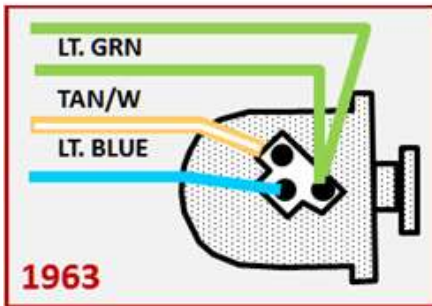

#1445 Bulb

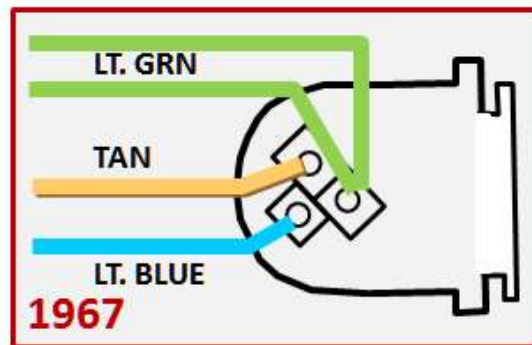
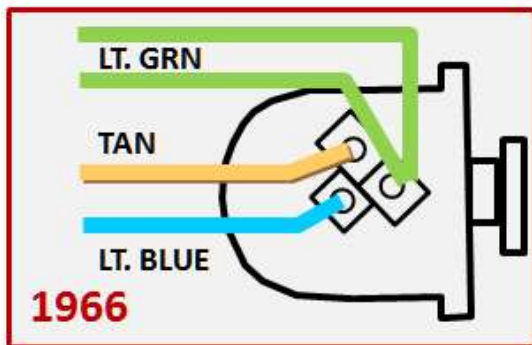



## Testing the cluster High-Beam-Indicator Lamp.



Testing the cluster High Beam indicator lamp. Put power to the terminal shown by the arrow. This is the dimmer switch connector. 1966 shown, other years colours may be different.

p.s. Headlight switch must be pulled out to 2nd detent.

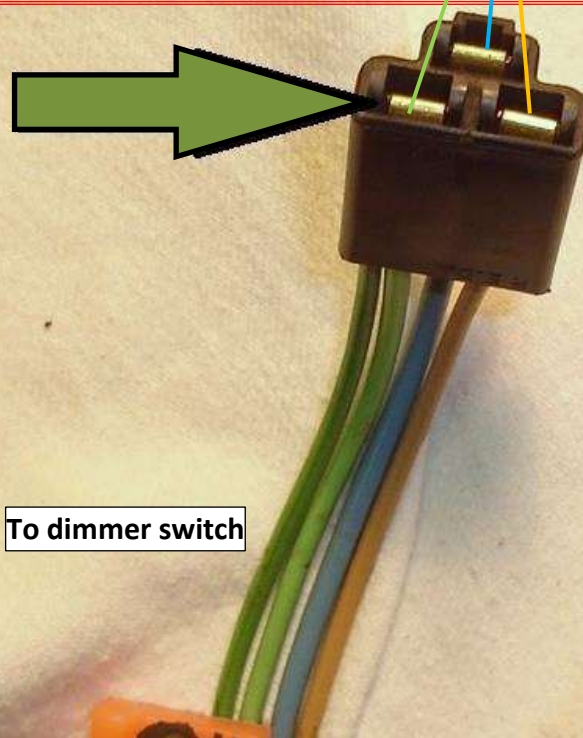

To dimmer switch

Buns 2016

## Mid-Year Corvette Windshield Wiper Switch Wiring

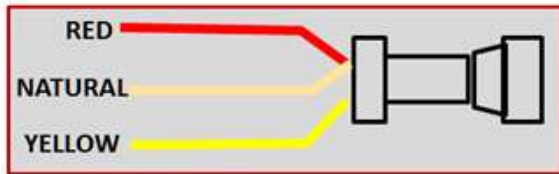

1963

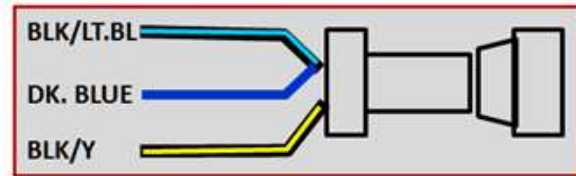

1964

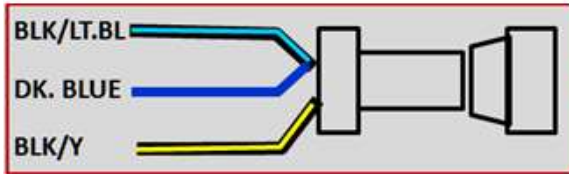

1965

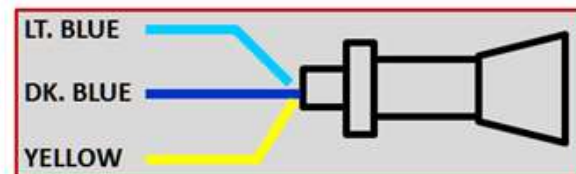

1966

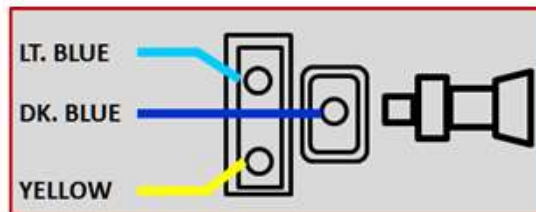

1967

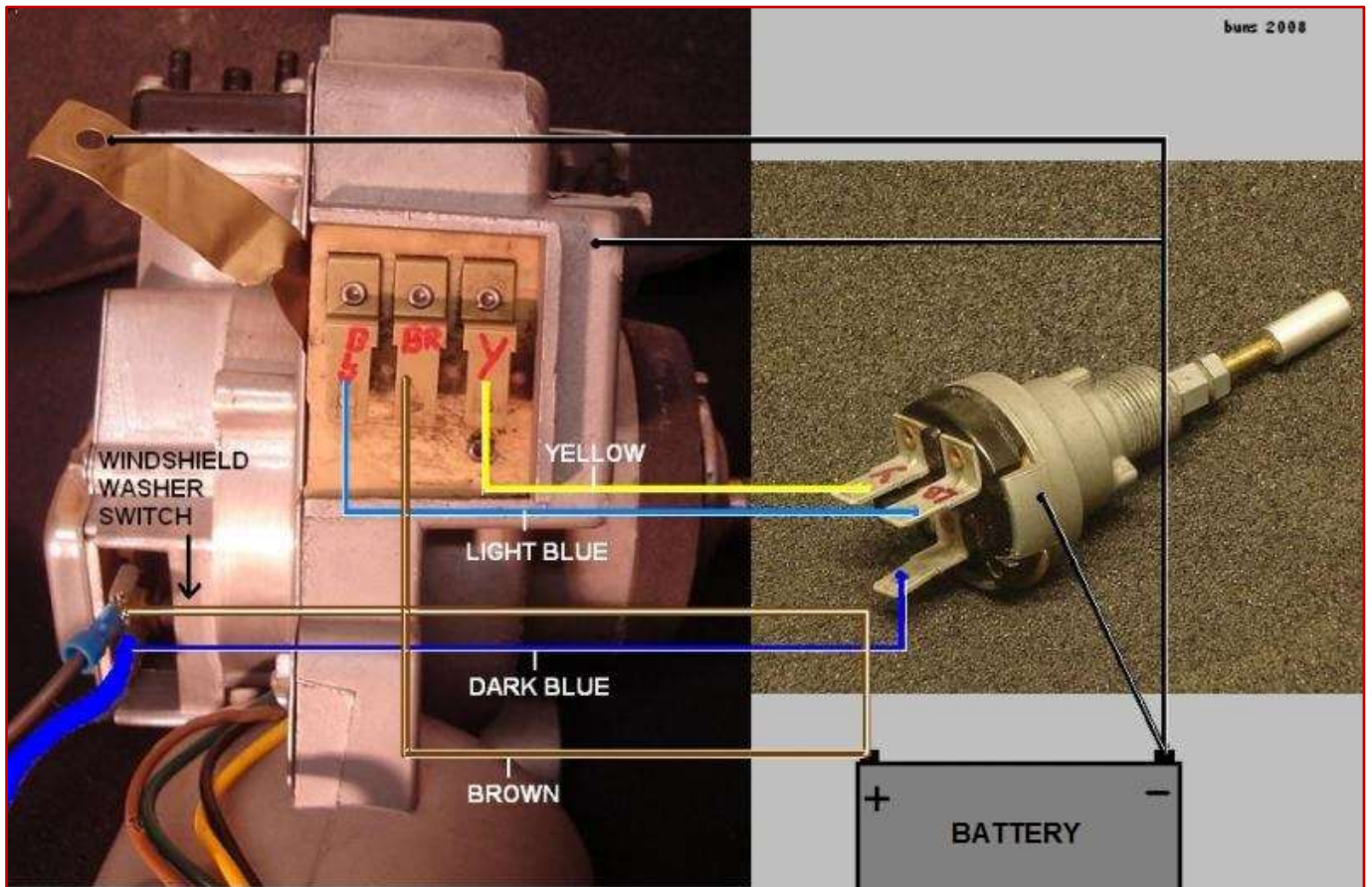

June 2008

### **BENCH TESTING A '66 WIPER MOTOR**

OTHER YEARS HAVE DIFFERENT COLORED WIRES BUT THE PROCEDURE IS THE SAME. MAKE SURE THE COPPER STRAP, MOTOR BODY AND WIPER MOTOR SWITCH ARE GROUNDDED.



## Mid-Year Corvette Parking Brake Alarm and Stop Lamp Switches

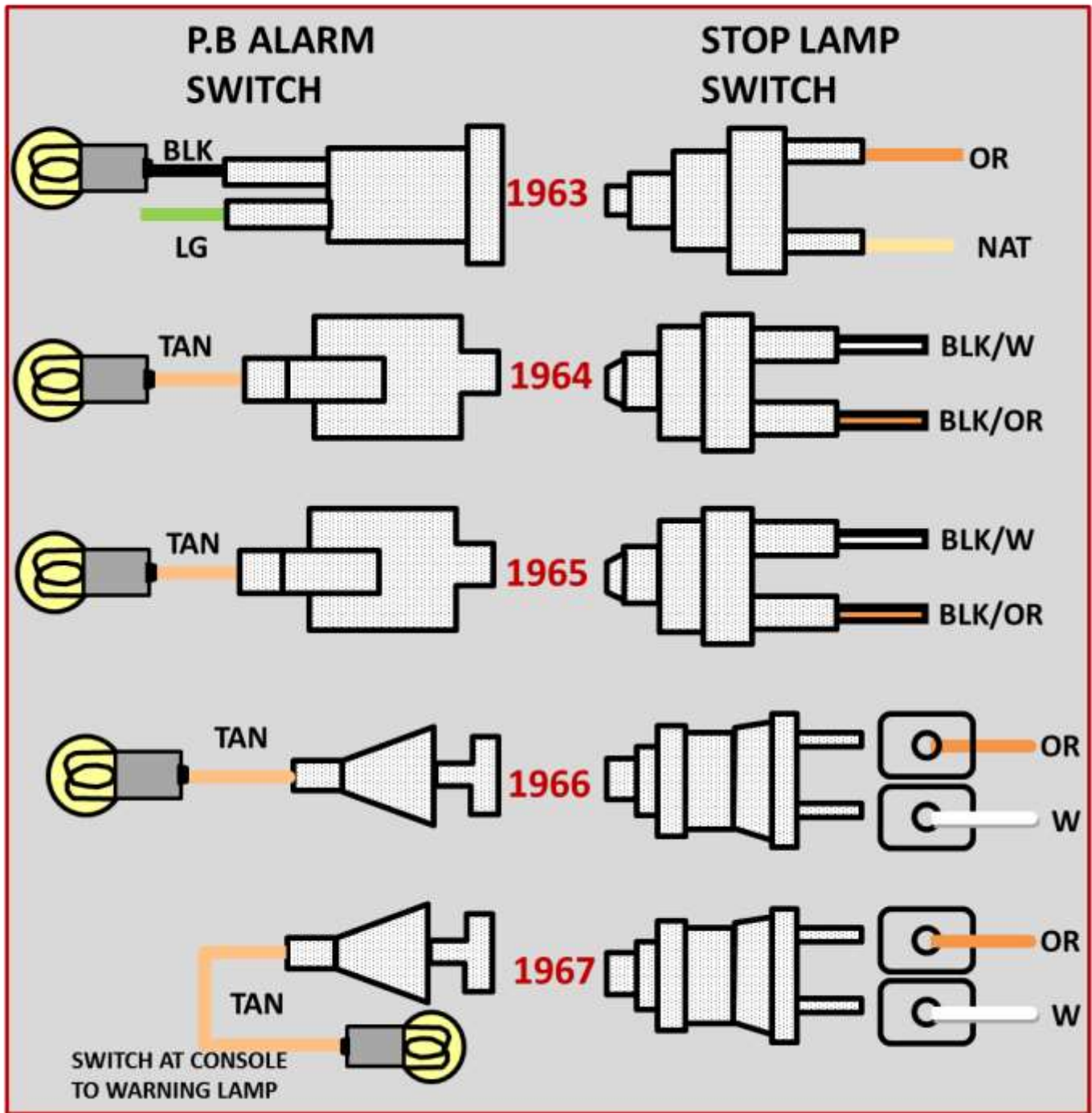

# Mid-Year Corvette Parking Brake Warning Lights and Parking Brake Switches

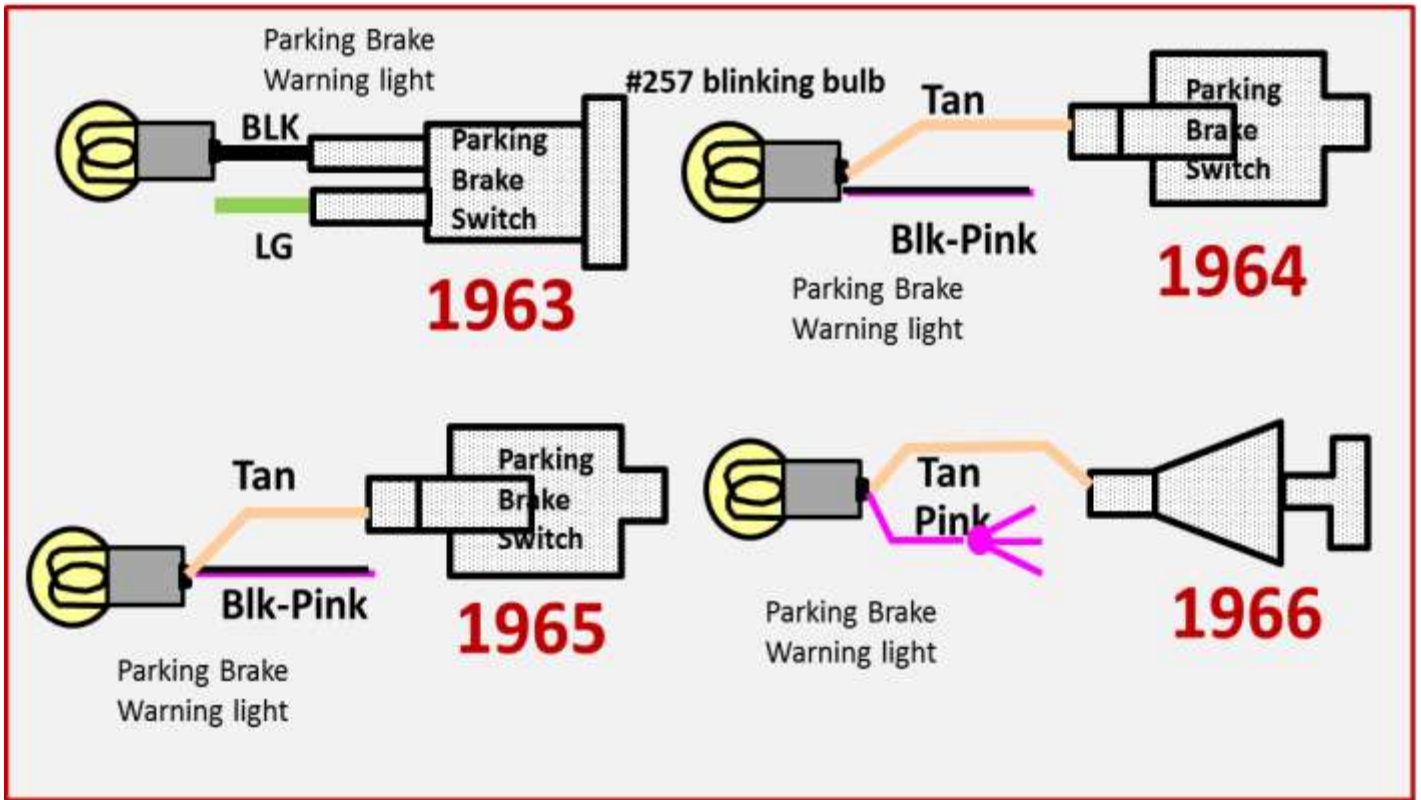

On the 1967, the tan wire from the warning lamp is routed through the rear body connector as the parking brake lever is mounted at the base of the armrest.

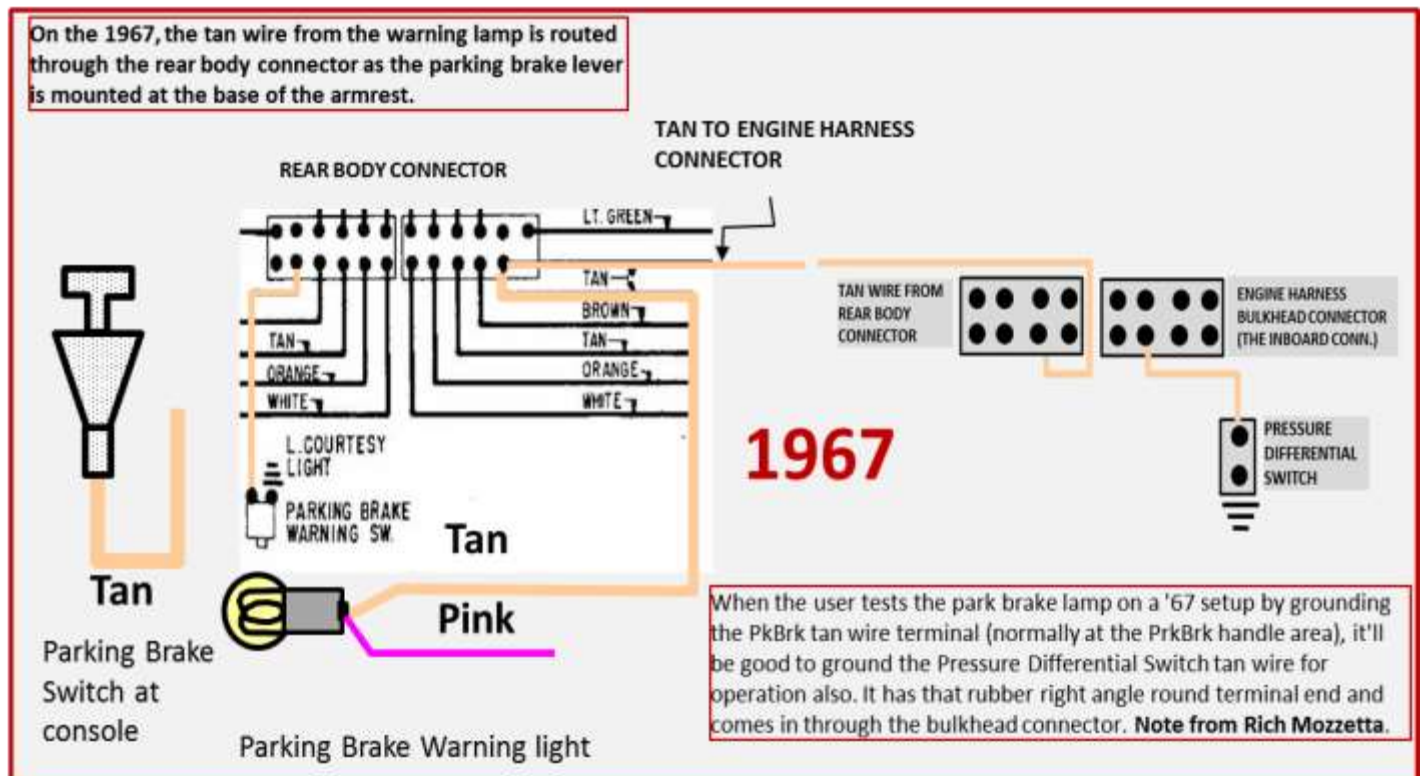

When the user tests the park brake lamp on a '67 setup by grounding the PkBrk tan wire terminal (normally at the PrkBrk handle area), it'll be good to ground the Pressure Differential Switch tan wire for operation also. It has that rubber right angle round terminal end and comes in through the bulkhead connector. **Note from Rich Mozzetta.**



## Testing the cluster Parking-Brake-Warning Lamp.

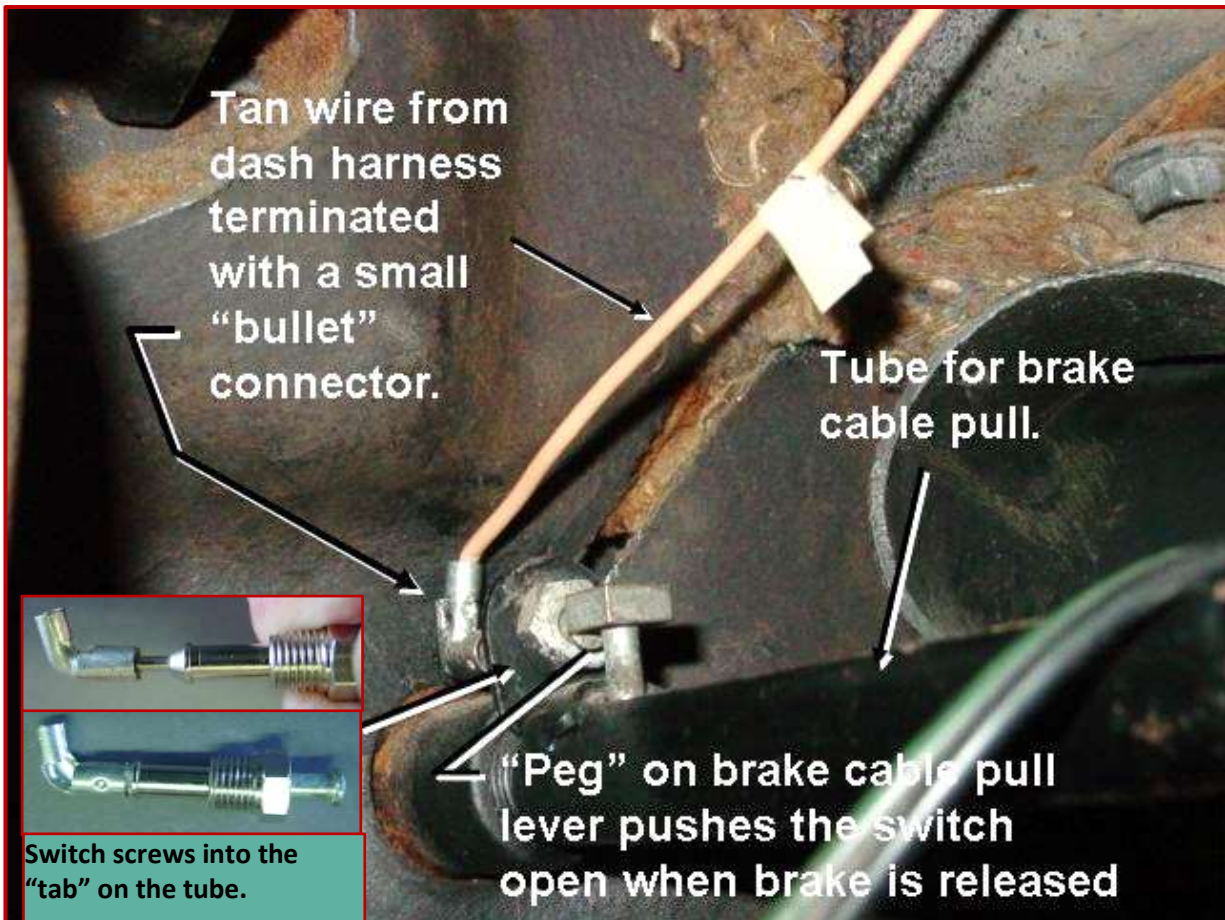
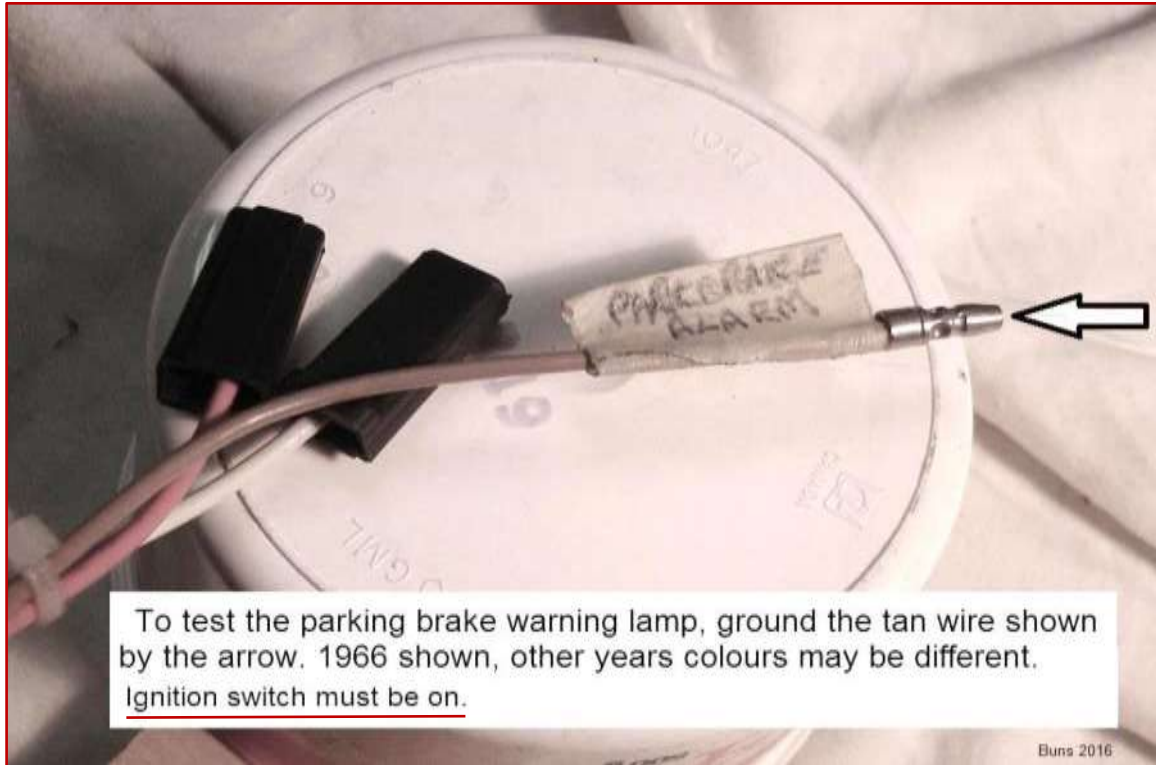



## The all-important cluster and dash harness ground connections:

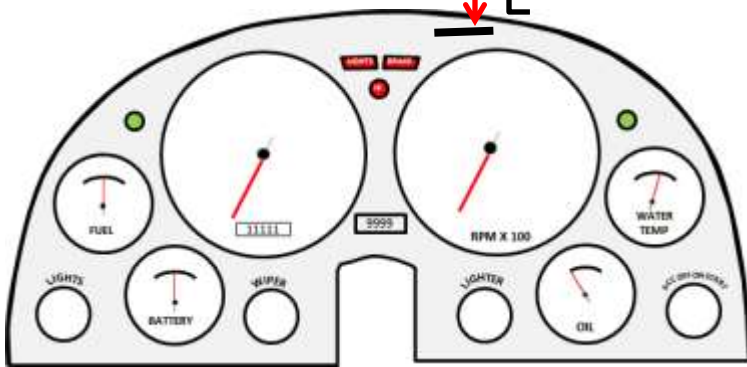
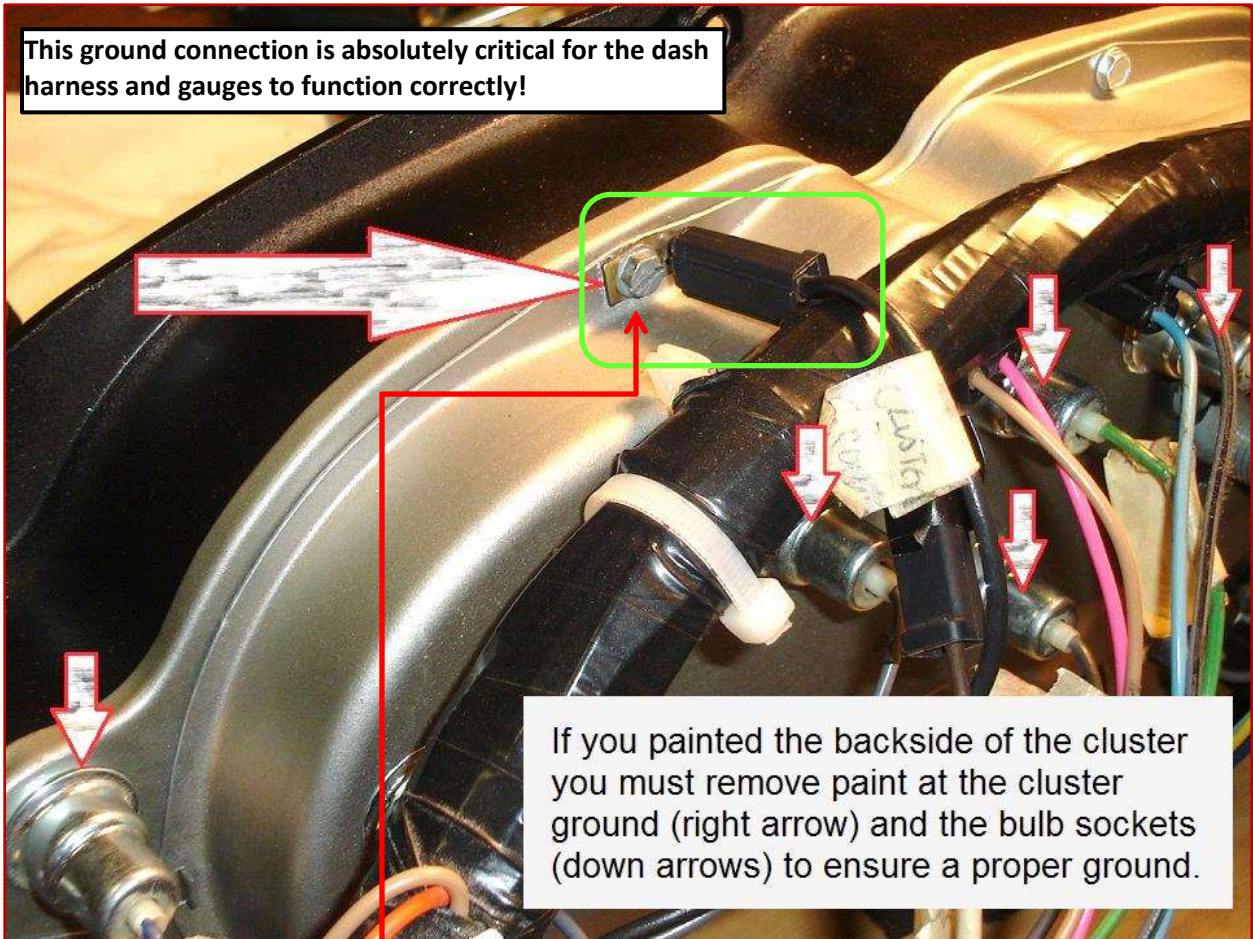

The **main grounding point for the dash harness** is the 14-gauge black wire with the ring terminal that comes from the middle leg of the radio connector and connects to the underside of the z-bar ("dash cross member") in an area just to the left of the radio side panel. **If you have a "radio delete" car, be sure to make the ground connection to the z-bar!**





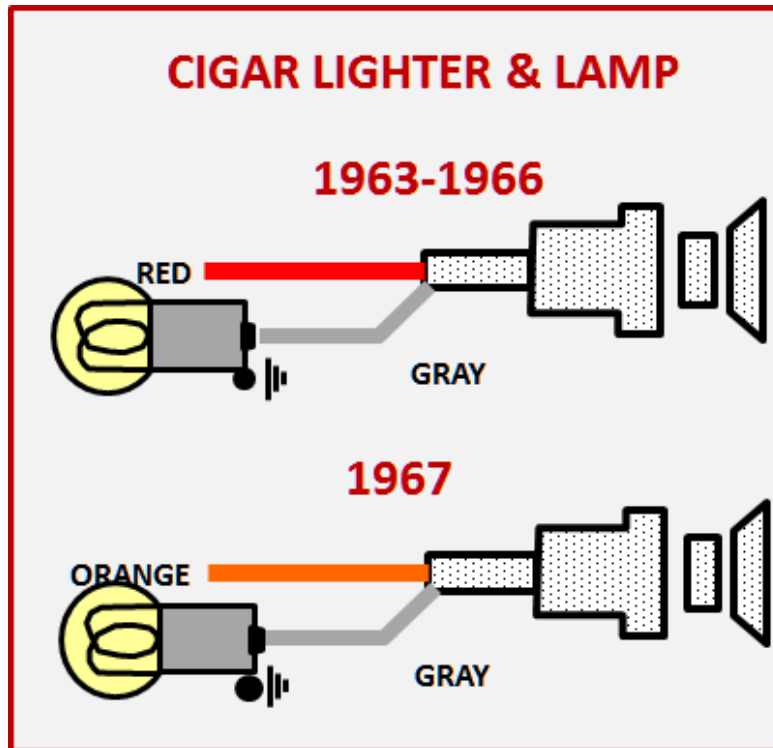

The cigar lighter wire is red for the '63-'66 years and changed to orange in 1967. The lamp wire is gray like all the other dash light and the bulb clips into slots on the lighter housing.

#### A note about adding a fuse to the cigarette lighter wire:

(From the Corvette Forum C1-C2)

Quote:

Originally Posted by [66since71](#)

*Edit: seems like JohnZ recommended adding a fusible link to the wire to the lighter socket, as it has no fuse in the factory harness?*

JohnZ

True, especially if you have a later reproduction lighter housing; they have a designed-in bimetallic element that dead- shorts the lighter to ground when it sees too much heat, which blows the lighter fuse. Unfortunately, **pre-'67 Corvettes didn't have a fuse on the lighter circuit**, so it'll just fry the harness from the lighter all the way to the horn relay. If you have one of those late reproduction lighter housings with the U-shaped bimetallic element on the center pin terminal (photo below), either remove the bimetallic element or put a 20-amp fuse in the red wire at the lighter. 🙌



## Mid-Year Corvette Oil-Pressure Gauge (Mechanical)

Brass Bourdon tube that “uncoils” under pressure load pulling the links at the bottom apart to rotate the needle to the right as viewed from the face of the gauge.

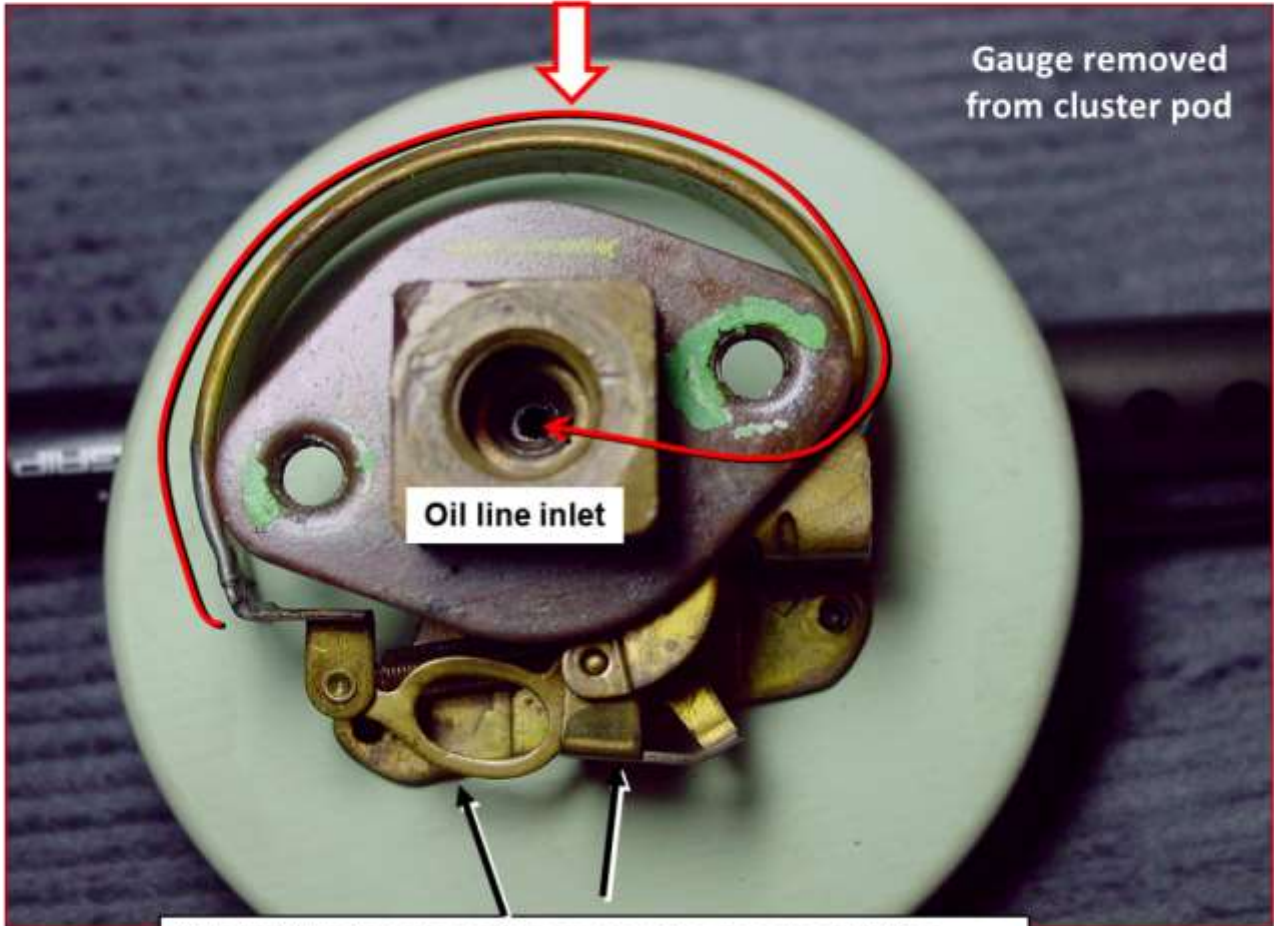

“Links” that pull apart to cause the needle rotation

Note: This is an 80-lb gauge that came out of my 1965. DZ

Oil line fittings for line to block

1/8" pipe  
Thread  
into block

7/16

3/8

Note taper in  
block fitting to  
accept the  
matching tube  
fitting

Note: the oil-pressure line is “copper coated steel” NOT COPPER



Be sure to hold the fitting on the gauge with a backing wrench when you tighten the line fitting into the gauge!





# Mid-Year Corvette Temperature Gauge Wire Colors

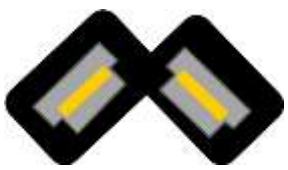

## Mid-Year Corvette Temperature Gauge Wire Colors

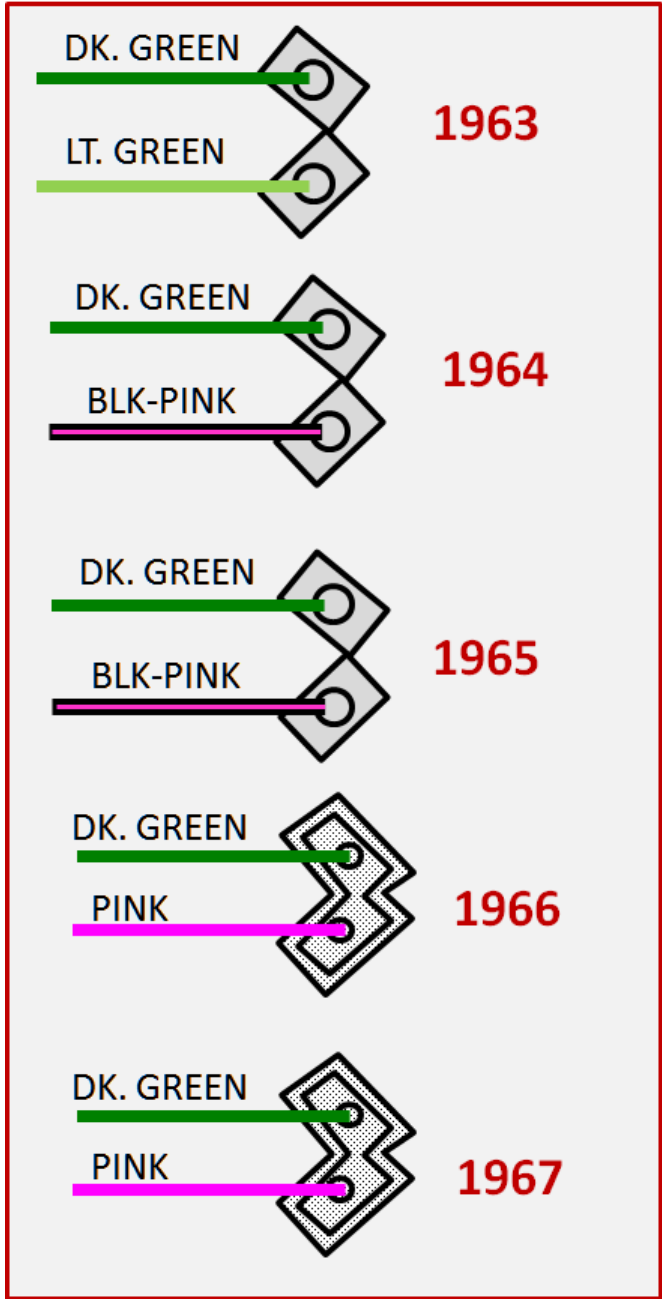

## Bench Testing the Temperature Gauge:

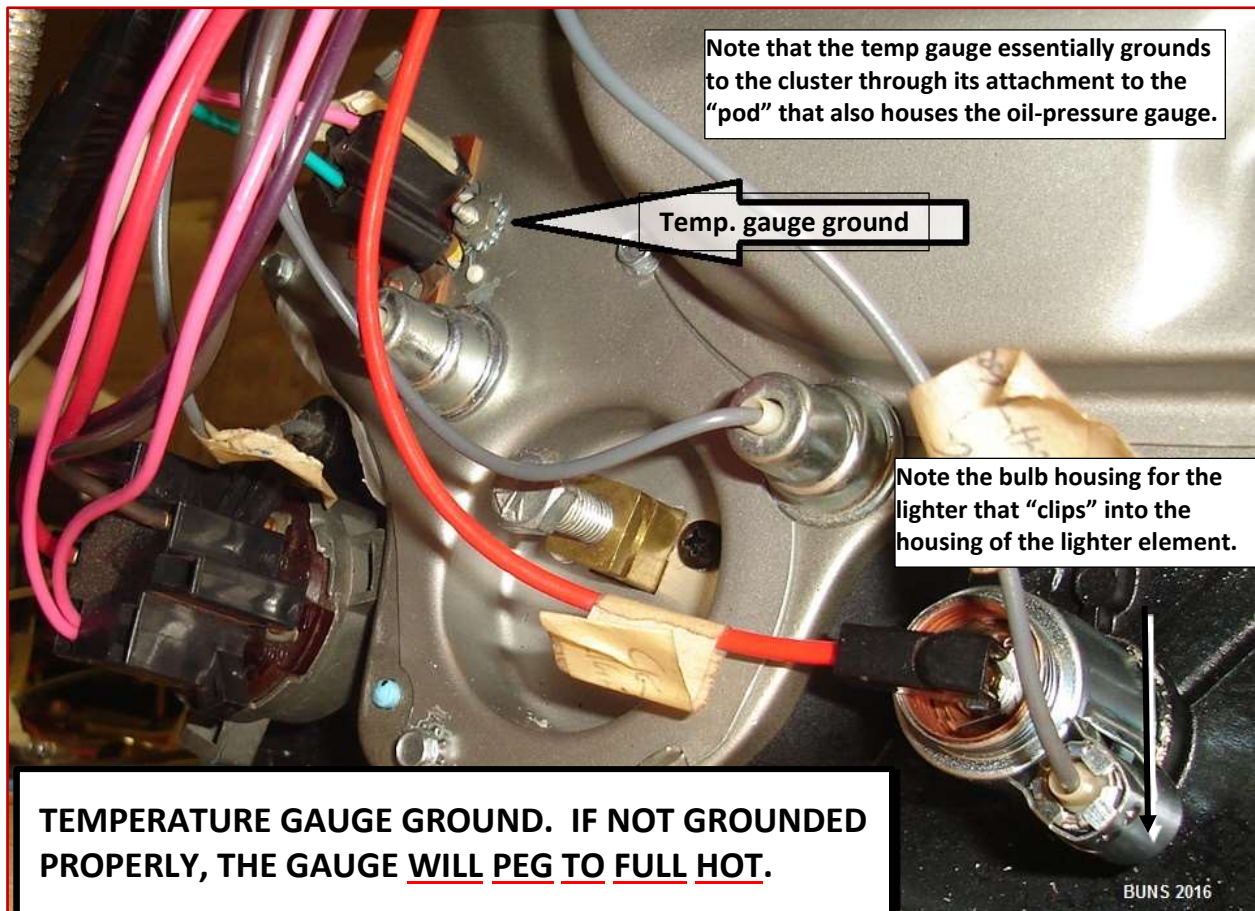
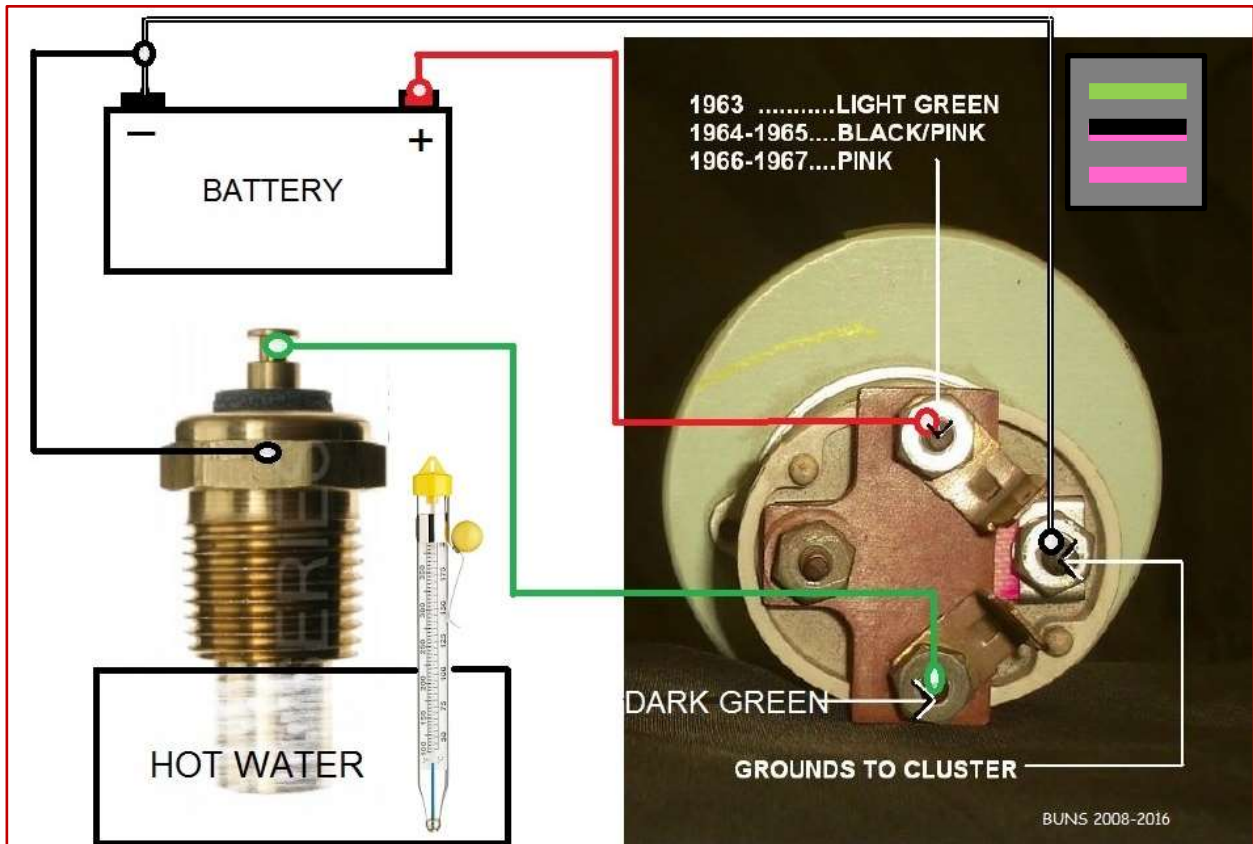



## Mid-Year Corvette Ignition Switch Wiring

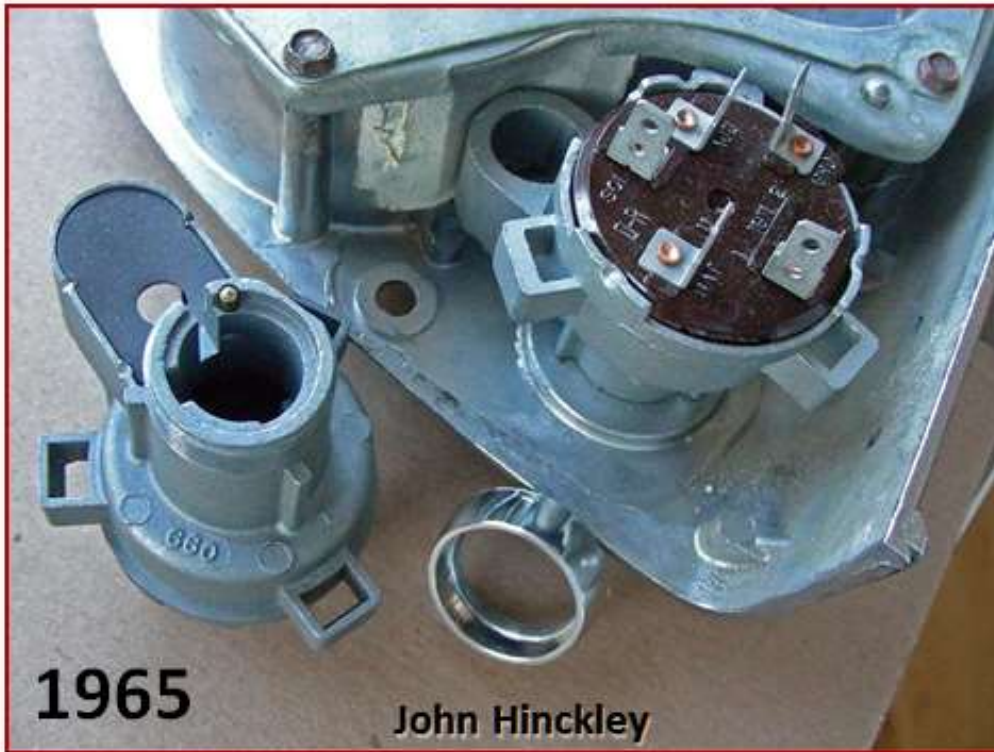

This photo, courtesy of John Hinckley, shows the **1965** ignition switch (front and rear views). It nicely illustrates the lamp socket “extension” and the threaded dash bezel and how the switch is mounted to the rear of the cluster.

**Note:** replacement ignition switches may or may not come with an auxiliary bulb mount fixture. The bulb socket mount is not cast into the housing of the replacement switches.

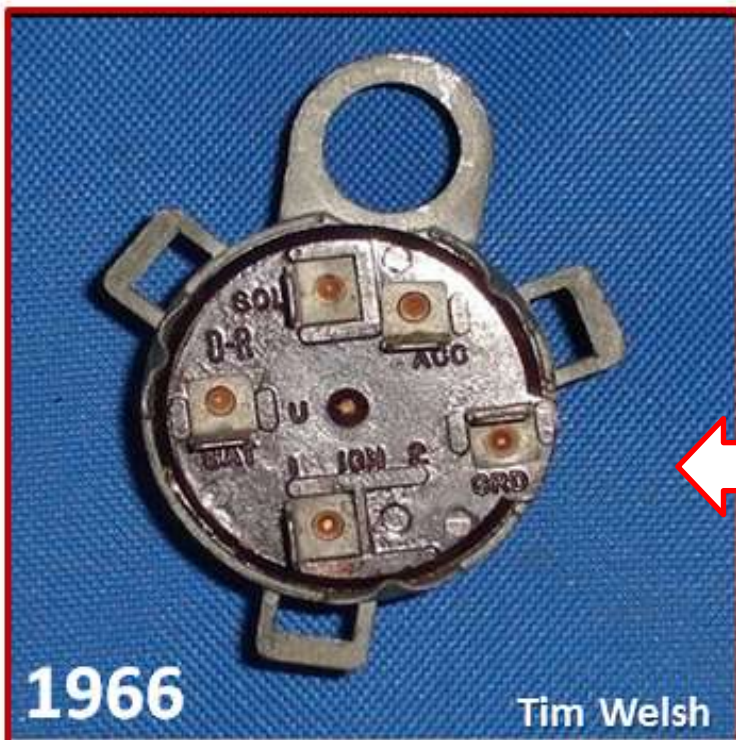

This photo was posted to the Corvette Forum (C1-C2) by “buns”, a.k.a. Tim Welsh in this thread:\

<http://forums.corvetteforum.com/c1-and-c2-corvettes/2175306-wiring-complete-and-a-few-issues-3.html>

	63	64/65	66/67
ACC	BROWN	BROWN	BROWN
BATT	RED	RED	RED
SOL	VIOLET	PURPLE	PURPLE
IGN	PINK	BLK/PINK	PINK

## Mid-Year Corvette Ignition Switch Connections

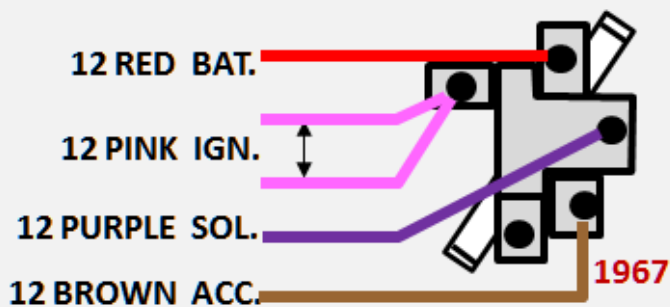
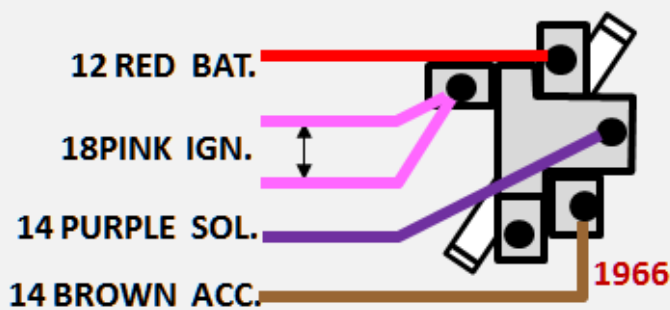
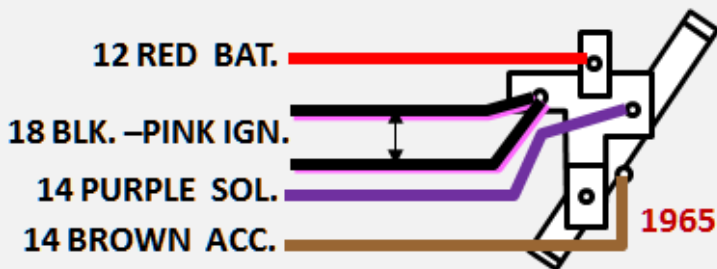
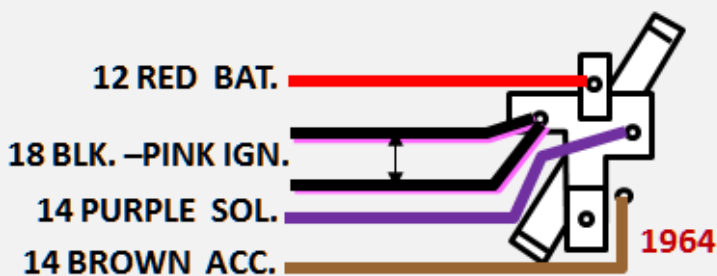
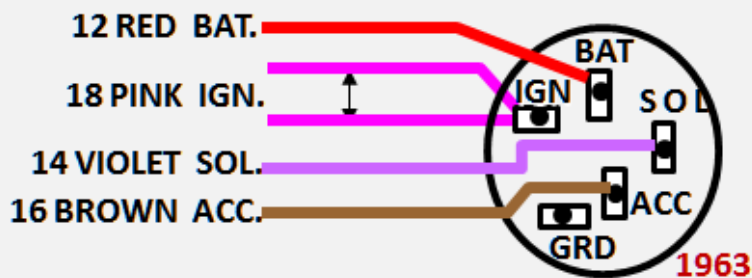



## Testing the ignition switch – power to ballast resistor:

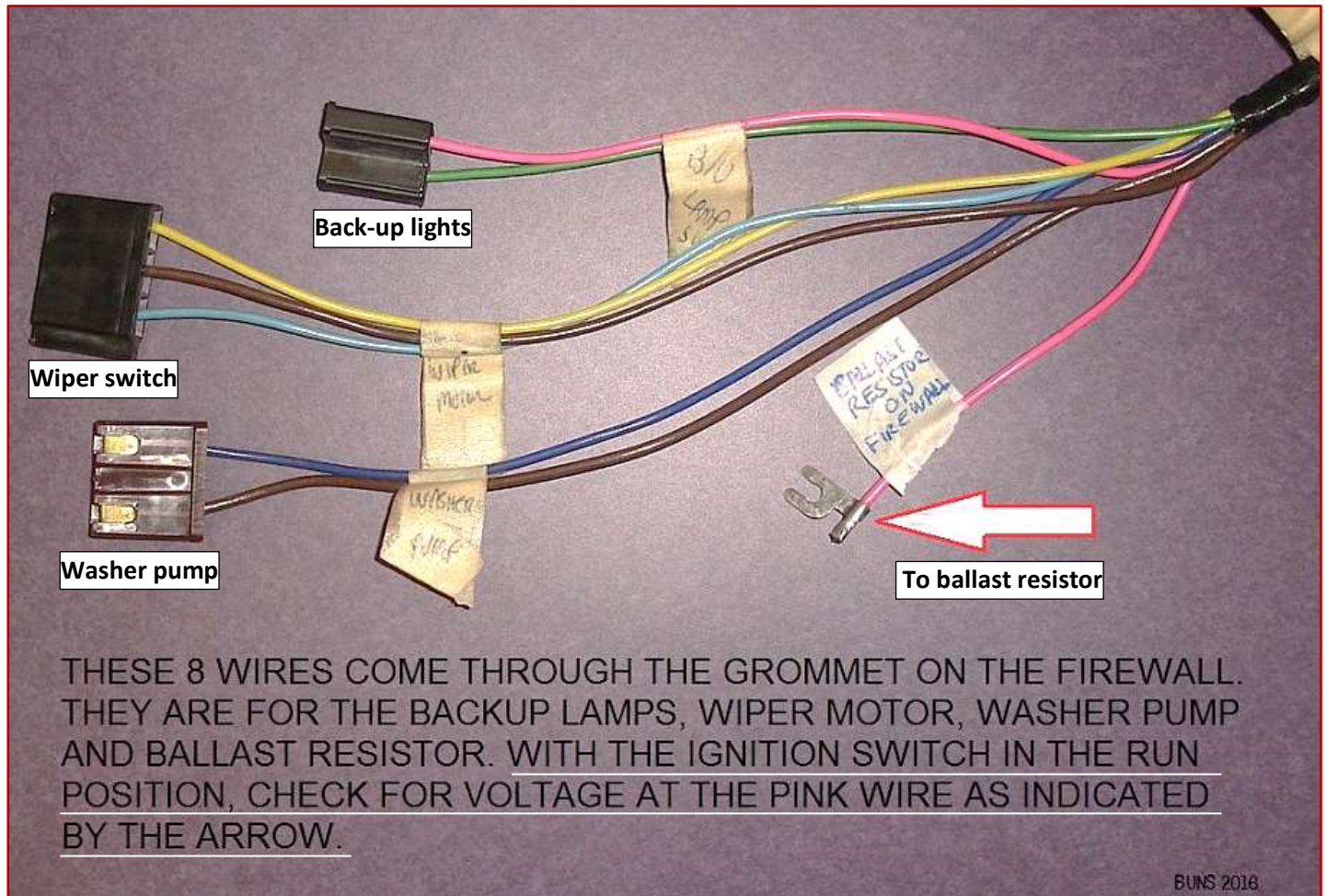

# Mid-Year Corvette Clock Wiring

Although technically not a part of the "cluster", we include the clock wiring here as it is a component often removed by owners working on the dash.

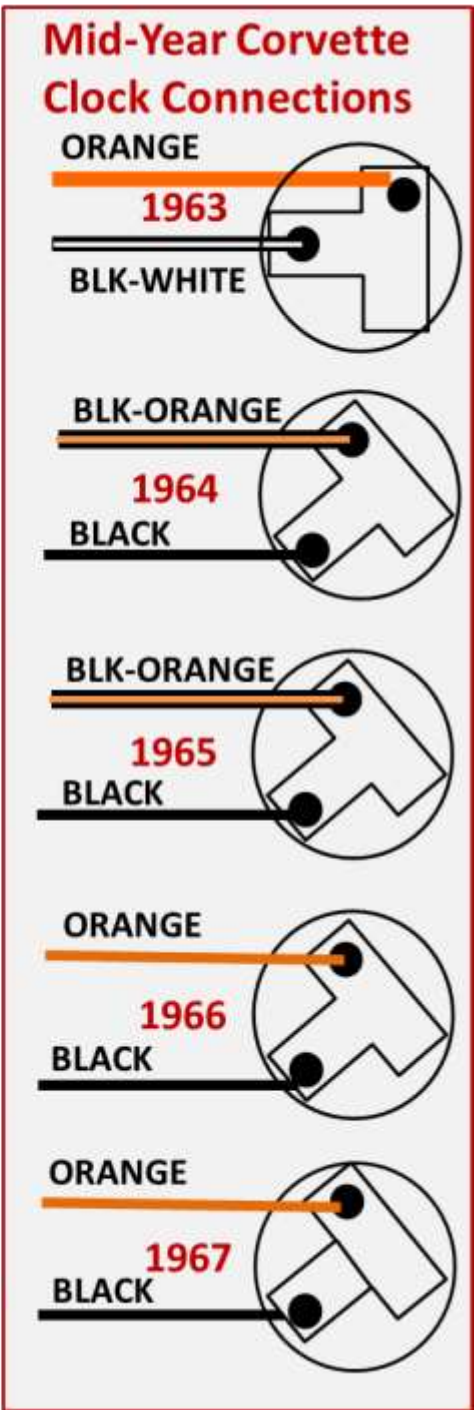
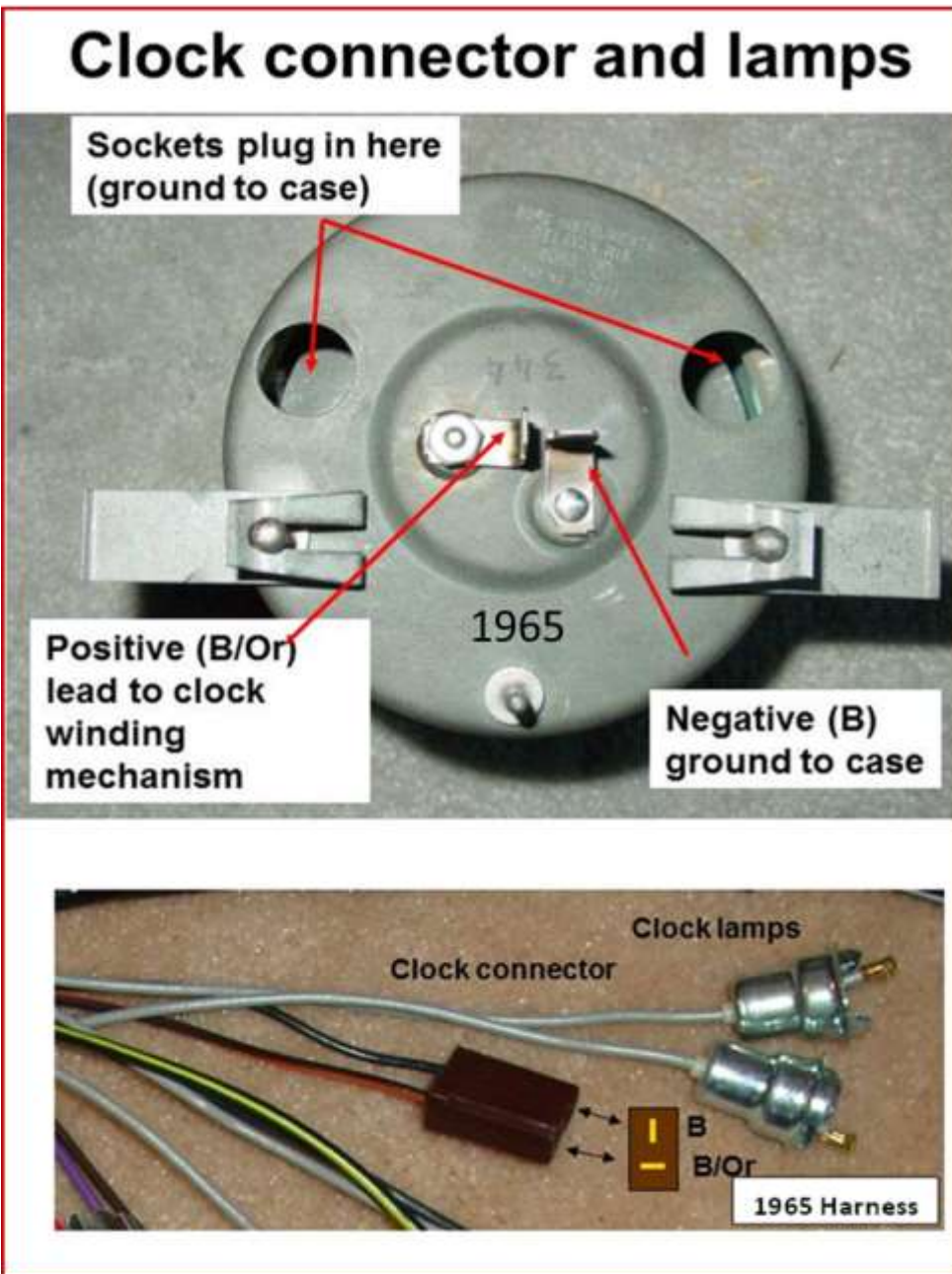



The following illustrations show the locations of the various indicator lamps and panel lamps on the cluster from DZ's '65 coupe. Also shown are the two main groups of wires and connectors from the dash harness.



All unlabeled holes (red circles) are for inst. panel lamps (gray wires). The red circle indicates that the switch comes with a fitting to plug the lamp socket into.



These two groups of wires from the dash harness service the instrument cluster.

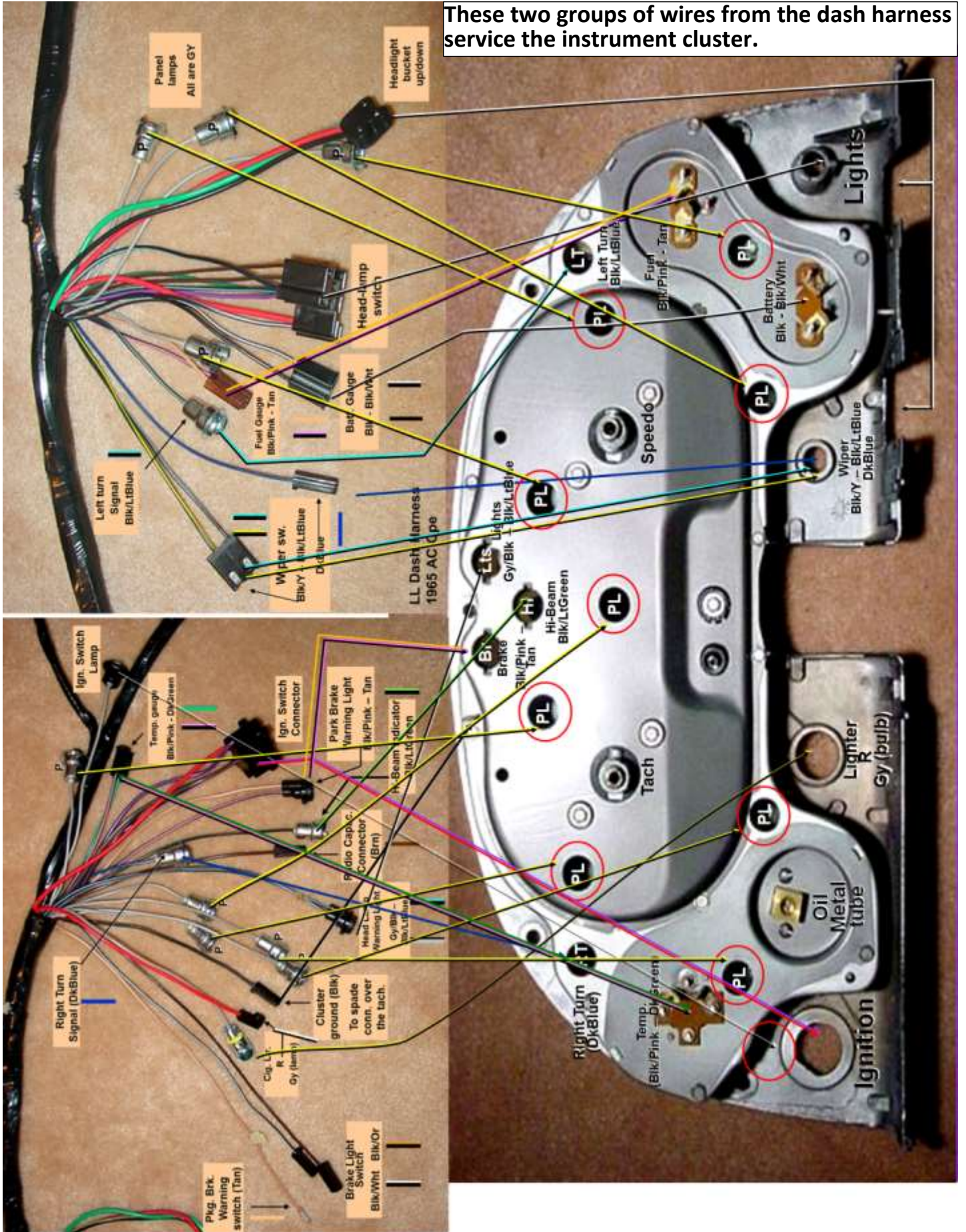



This the left side (driver) group of wires from the 1965 dash harness to the cluster.

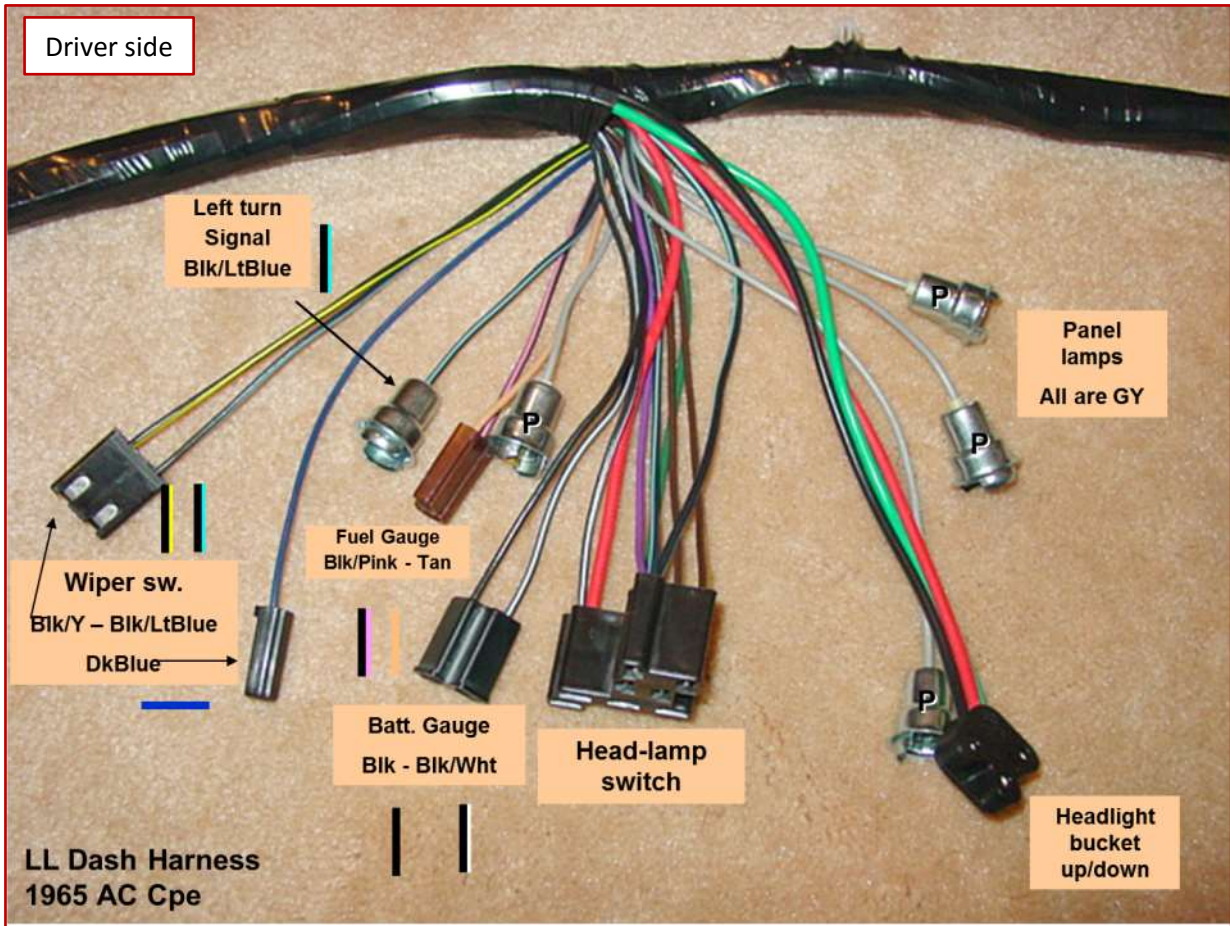

This the right side (psgr) group of wires from the 1965 dash harness to the cluster.

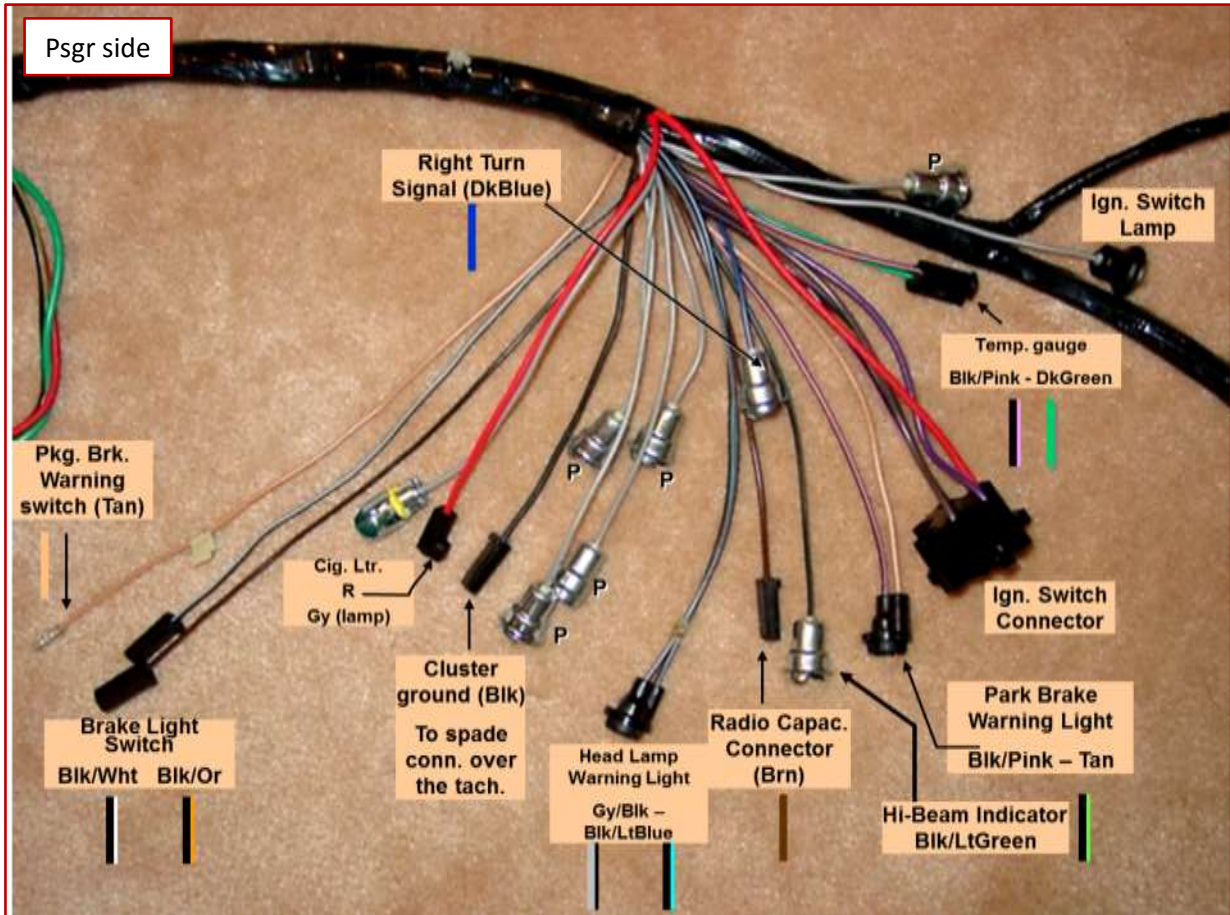

## Mid-Year Corvette Forward lamp Harness Bulkhead Connections

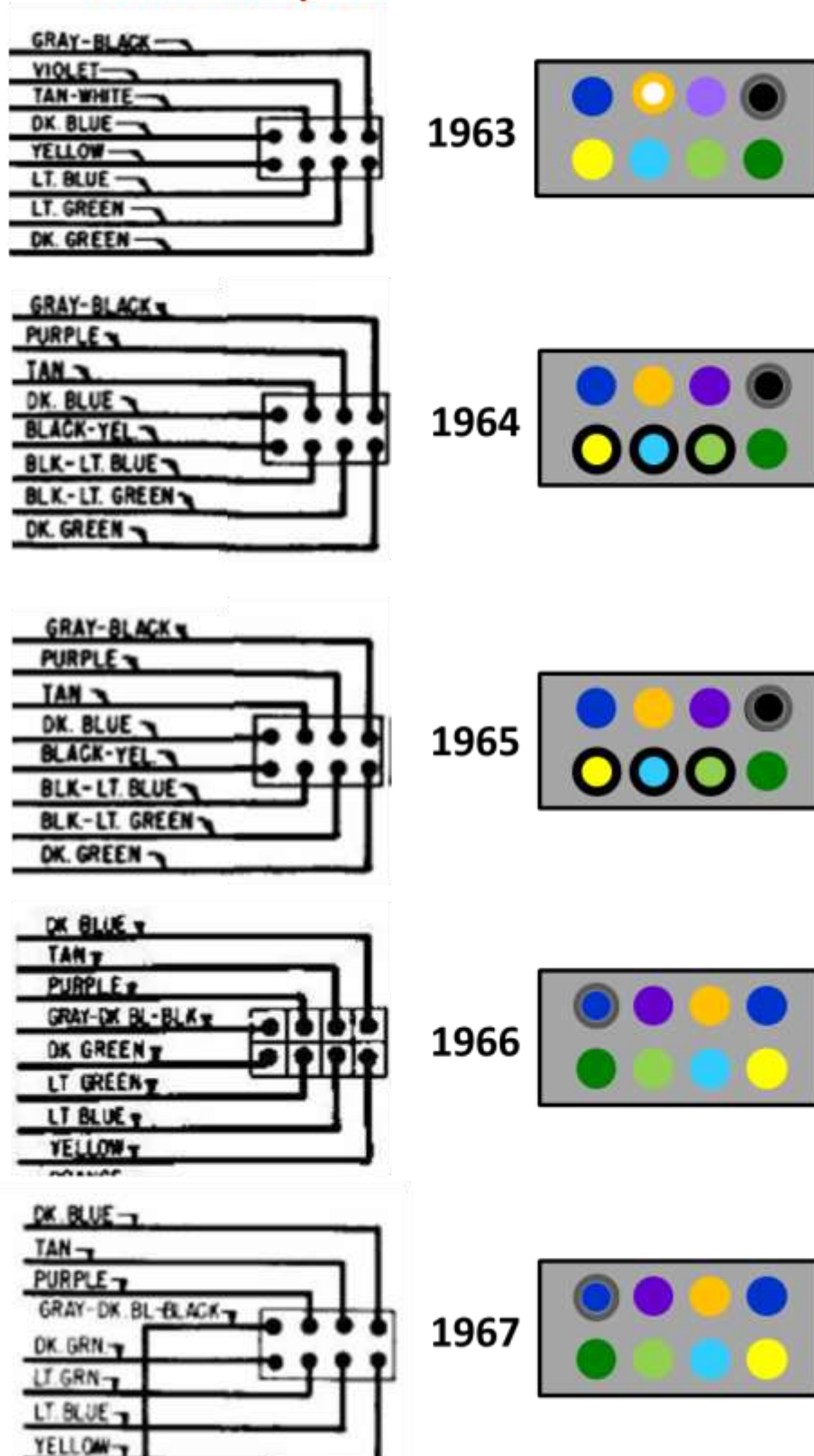

Note: these are the bulkhead connectors that the forward lamp harness connects to at the firewall. In other words, this is the one you see toward the outboard driver side on the firewall (see pg. 8). These are the configurations from the Mitchell Repair Information Co. diagrams.



The Mitchell Repair Info. Co. diagrams apparently show the wire insertions as viewed going into the rear of the connector. The GM diagrams show the wire locations as viewed looking into the front of the connector.

Mitchell Repair Info Co.

Diagrams

1963

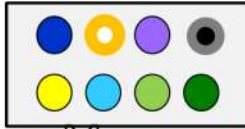

Forward Lamp Harn.

1964

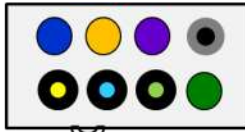

Forward Lamp Harn.

1965

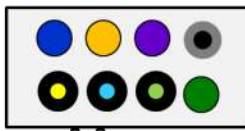

Forward Lamp Harn.

1966

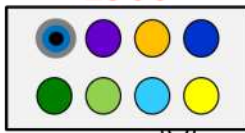

Forward Lamp Harn.

Note that for the '66 & '67 Harnesses the locating tabs on the harness conn. are different in the GM diagrams. Thus to mate the connectors in the diagrams at right, you flip the harness connector over onto the bulkhead connector

1967

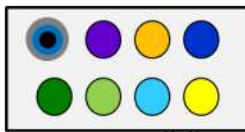

Forward Lamp Harn.

'63-'67 Corvette Ignition and Lamp Harnesses and Bulkhead Connectors  
Based on GM Wiring Diagrams from the A.I.M.'s of respective years.

Harness conn.

Bulkhead conn.

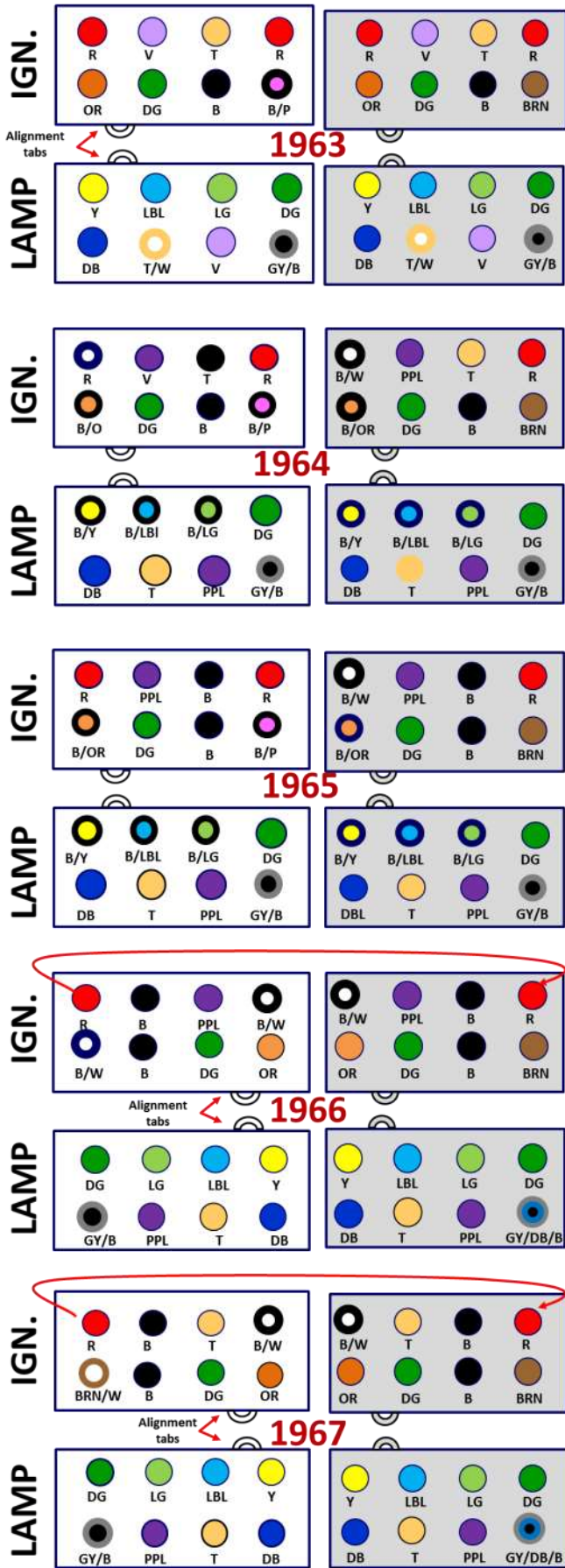

## GM Diagrams

Looking into the front of the harness connector

Bump toward center of fuse box

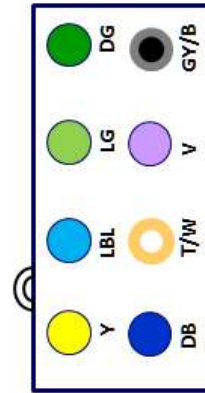
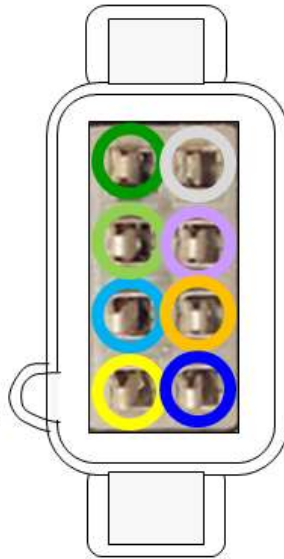

LAMP

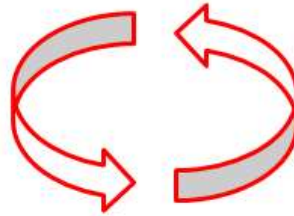

## Mitchell Repair Info. Co. Diagrams

Looking from the rear of the harness connector

Bump toward center of fuse box

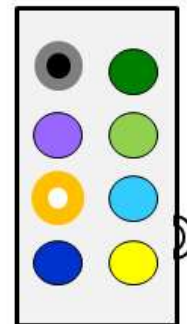
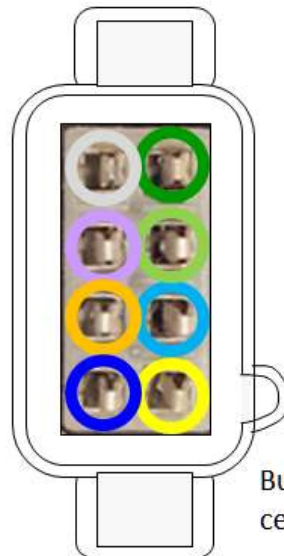



**1966 CORVETTE - AMMETER WIRING**

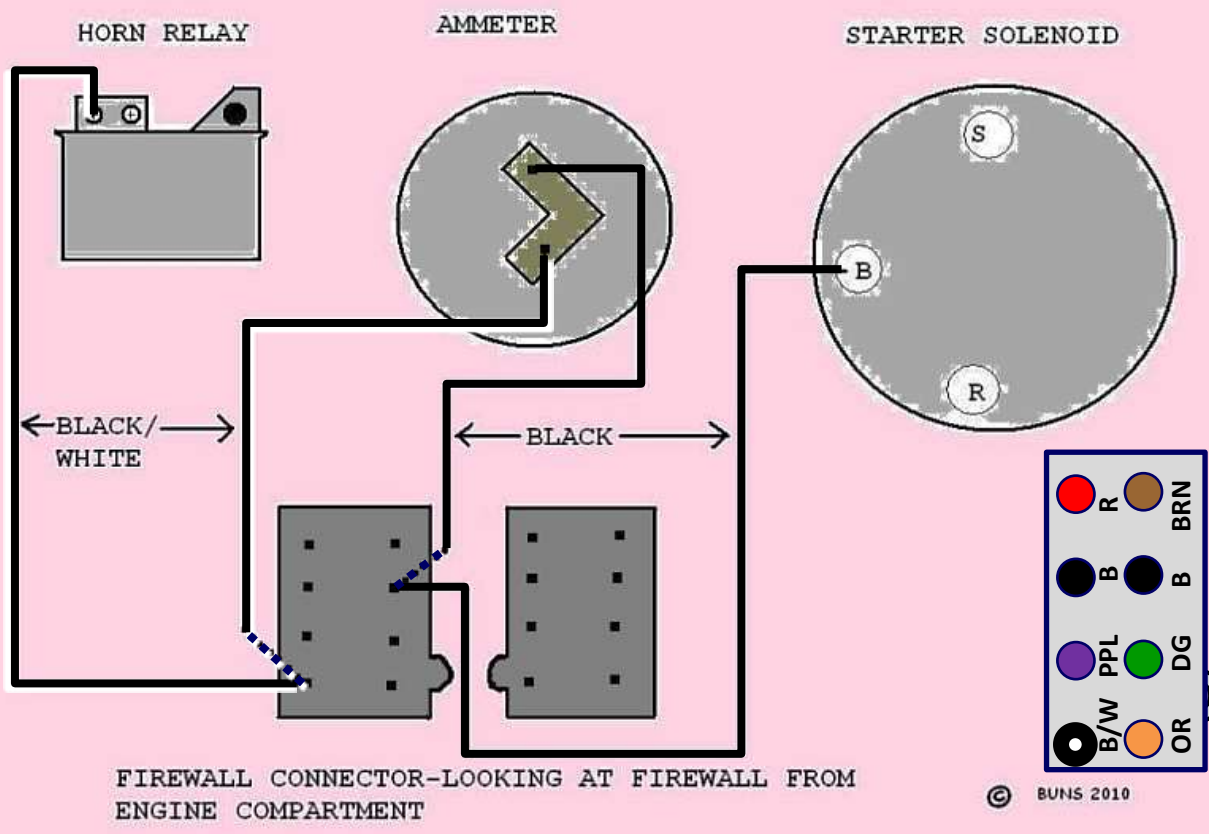

**1966 CORVETTE TEMP GAUGE WIRING**

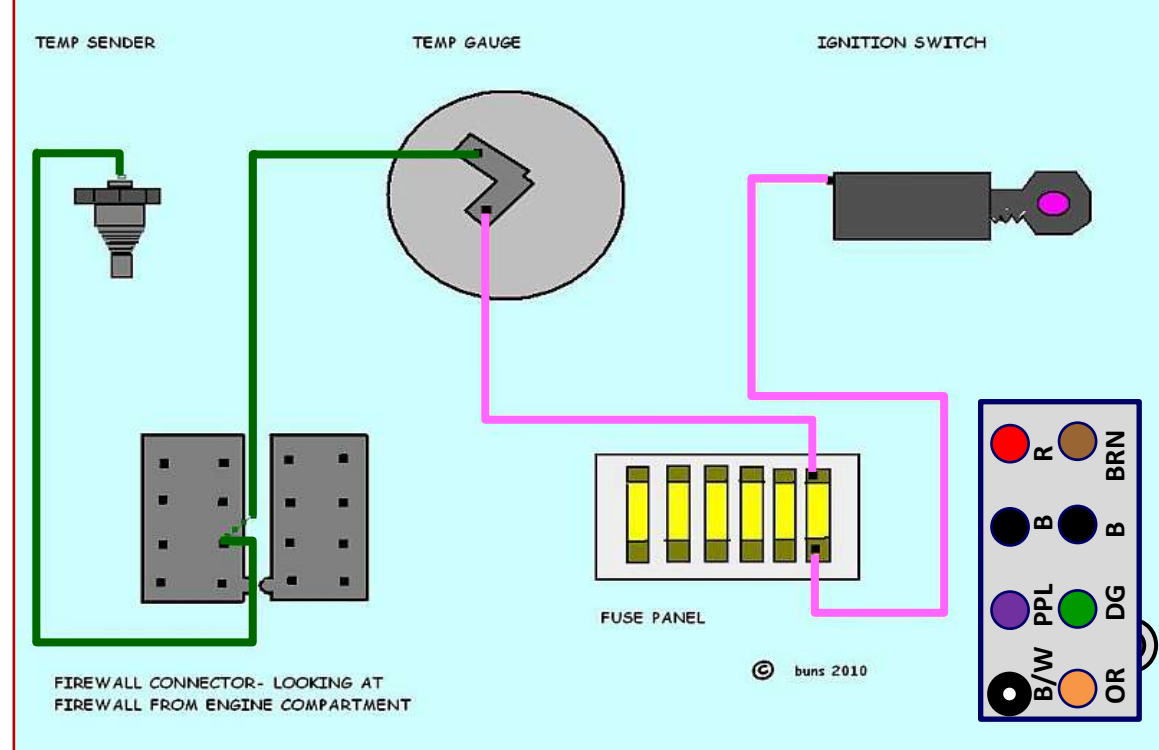

**1966 CORVETTE FUEL GAUGE WIRING**

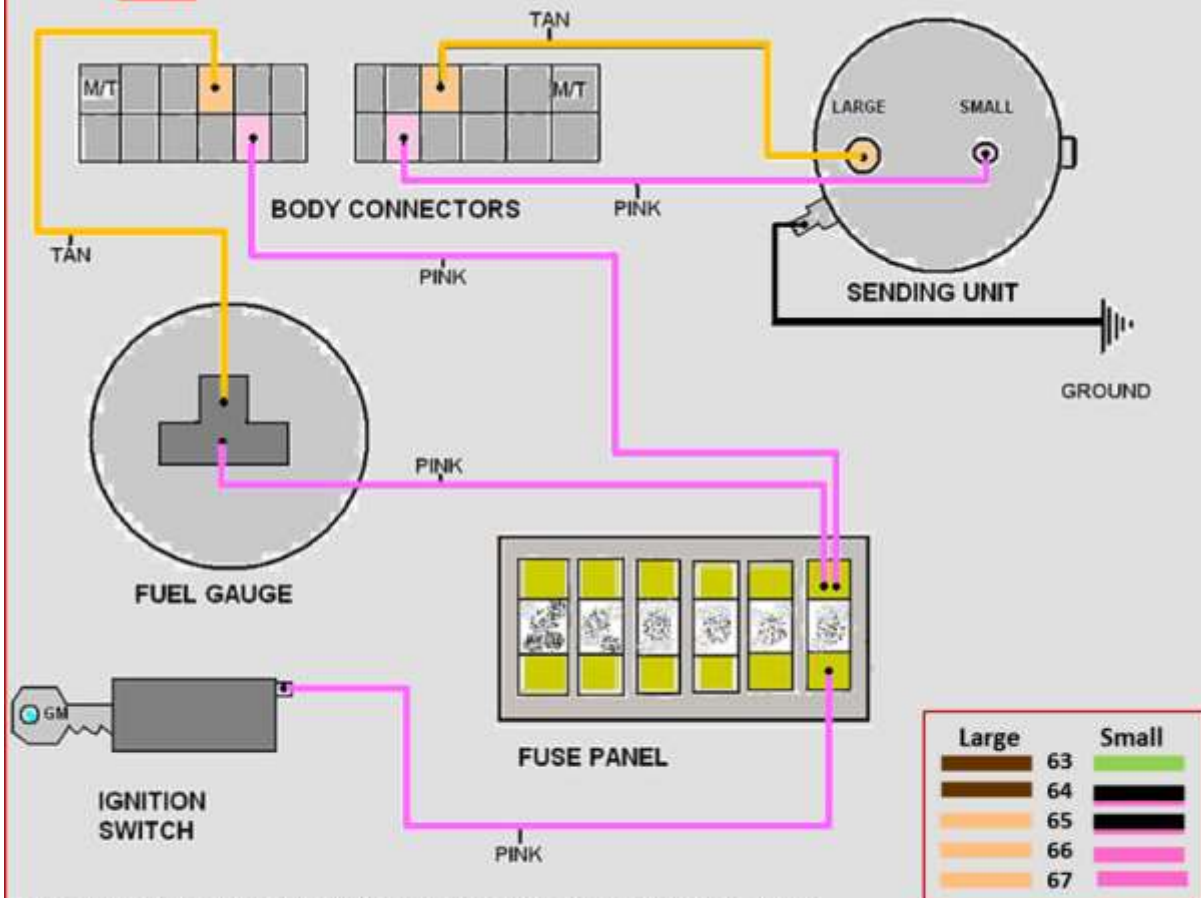

1963- WIRES ARE LIGHT GREEN AND BROWN- BODY CONNECTOR IS DIFFERENT  
 1964- WIRES ARE BLACK/PINK AND BROWN AT SENDER, BLACK/PINK AND TAN AT GAUGE- BODY CONN. DIFFERENT  
 1965- WIRES ARE BLACK/PINK AND TAN- BODY CONNECTOR IS DIFFERENT  
 1966/1967- WIRES ARE PINK AND TAN

© BUNS 2010