

Modified ACA installation guide:

Tools needed:

- Philips head screwdriver
- Torx 15 screwdriver
- Torx 20 screwdriver
- 8mm open end wrench
- 10mm wrench or socket
- 1/2" socket
- socket extension (6" ideally)

Phase 1: removal of old headlights:

1. Raise your headlight using the manual crank. You'll see 3 Philips head screws that hold the plastic trim bezel in place. remove these screws and the bezel



2. Next remove the 4 torx 15 screws that hold the headlight cover in place. 2 are on the back and there's one on each side. Remove these and the headlight cover. Be sure not to lose the plastic or metal sleeve for the bolts.

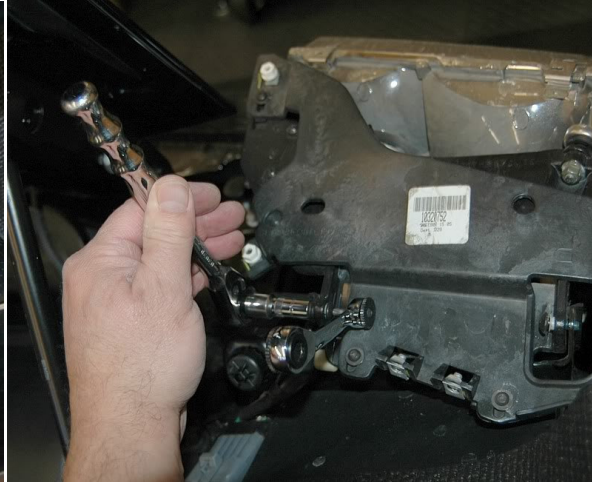

3. With the headlight tilted down, remove the 10mm nut that holds the headlight lifting arm to the headlight motor. Disconnect the headlight bulb sockets and remove the headlight (picture shows the placement of the nut without the headlight).

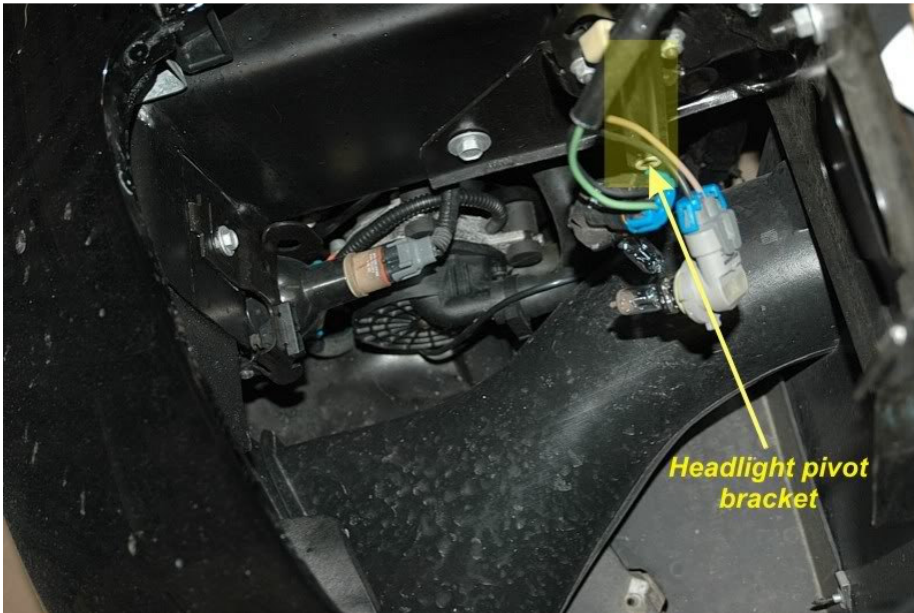

4. With the headlight assembly out of the car, remove the headlight housing by removing the three 10mm screws on the back of the housing. (you may need your socket extension to reach the bolts on the outer side).

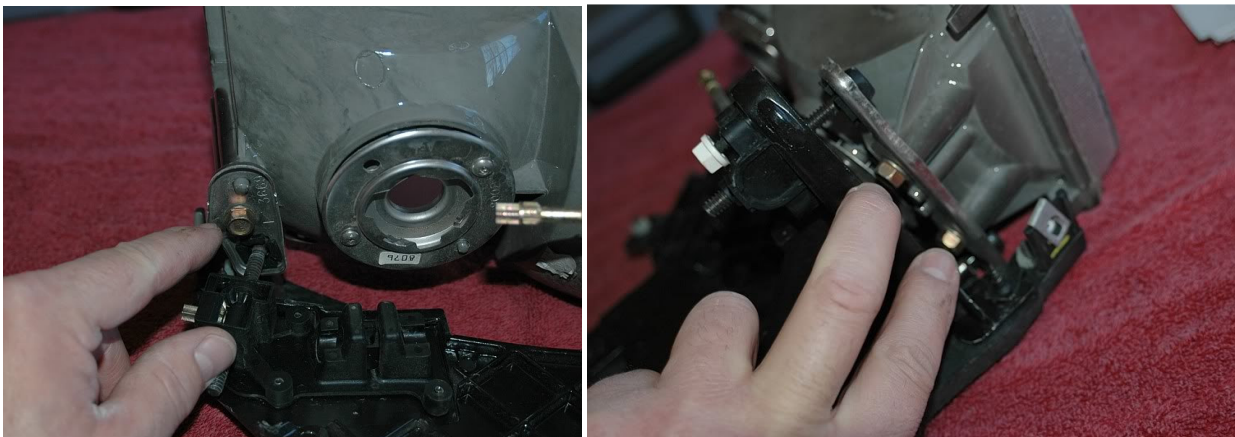

Phase 2: Installation of new headlights

At this point, it's a good idea to identify your factory headlight adjusters. I STRONGLY suggest shooting the gear mechanisms with WD40, PB blaster or similar lubricant compound as these have a tendency to seize up and sometimes break after many years of non-use. The short rod is your horizontal adjuster and the long one is the vertical adjuster. You'll need to remember this when aiming.

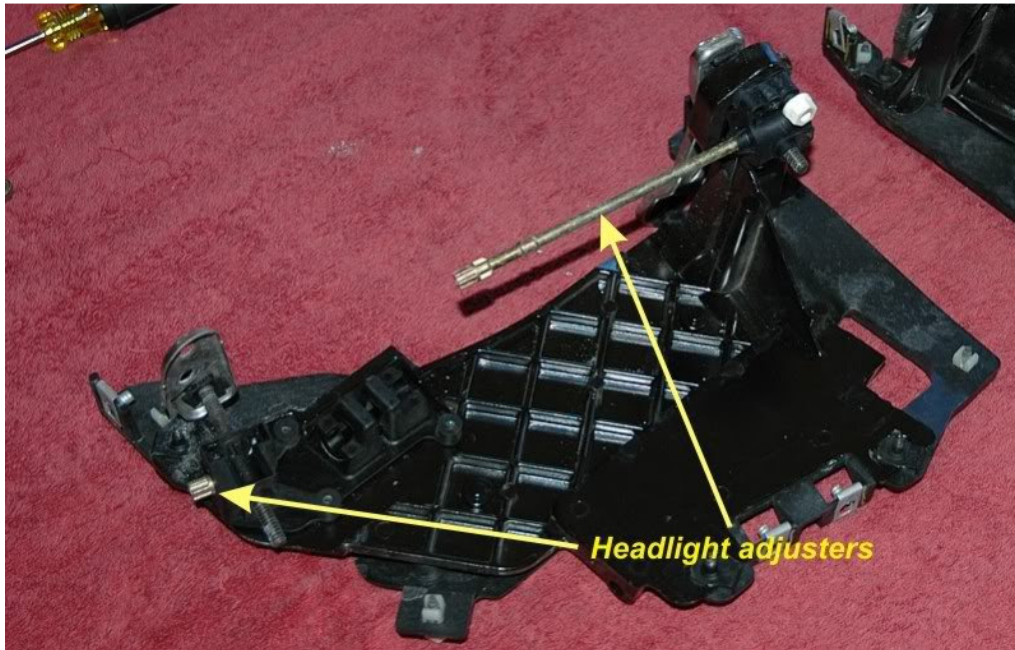

1. Install the new headlights using the same mounting screws removed from the factory headlights



2. Your HID ballast can be mounted several ways:

a - use the supplied cradle mount and bolt the cradle to the headlight frame using one of the three 10mm nuts that hold the frame to the wheel well or the 1/2" bolt that holds the headlight frame to the frame rail



b - use the supplied double-sided tape in the small ziplock bag to adhere the ballast to a clean flat area of your choosing. (make sure the area is clear of the headlight when it moves up and down and the wires will not snag during this motion)

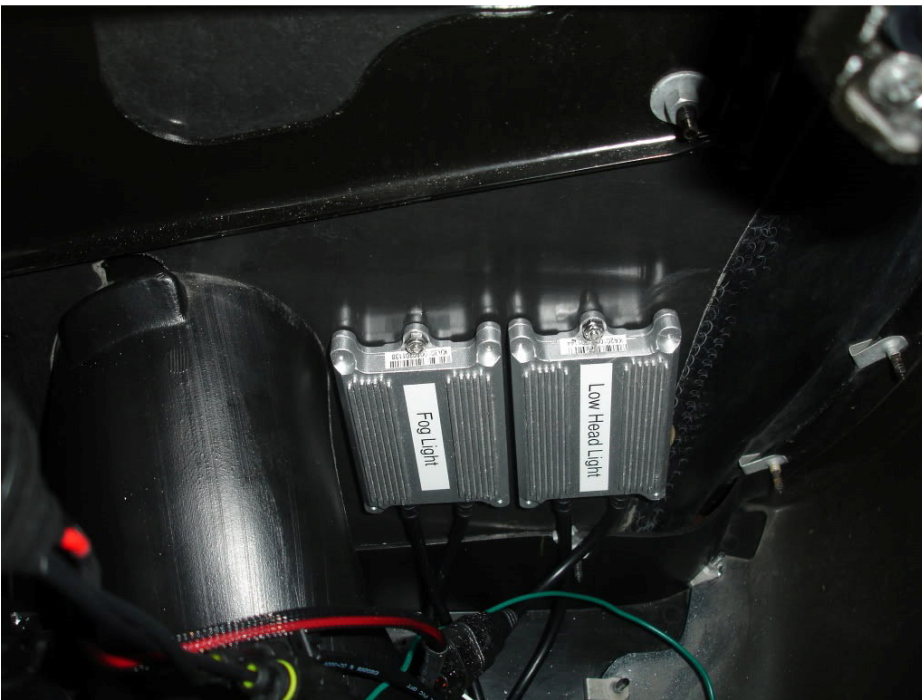

c - You can also make a VERY secure, yet easily removable mount by drilling through the wheel well wall and bolting the ballast directly to the wall.

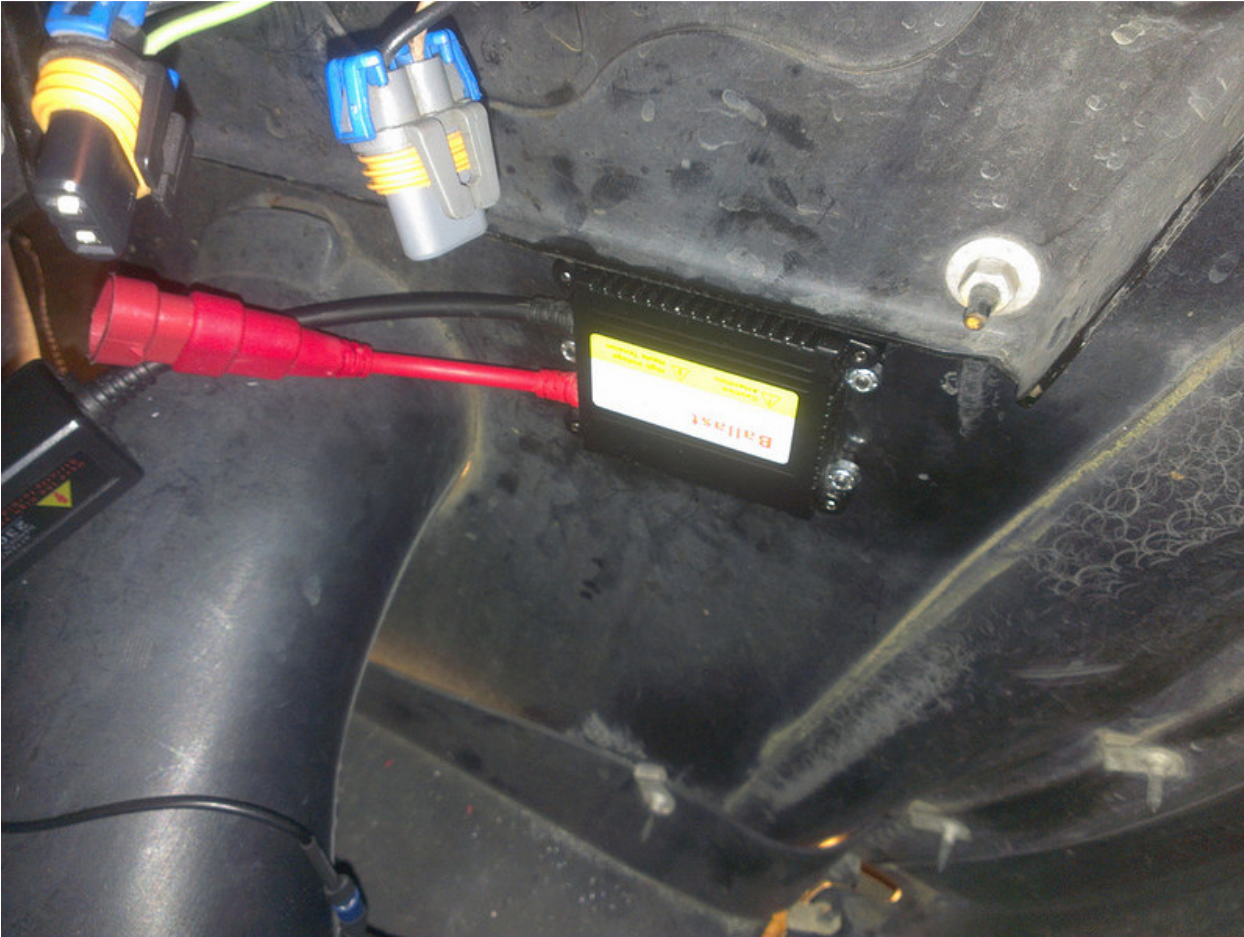

3. Connect the Factory low beam connector directly to the ballast. You will need to plug the ballast the connector in backwards to get correct polarity. When done correctly, the locking clips will be on the opposite side of the locking tab.

(Note: Kits Shipped after 10-25 will have a - / + markings on the back of the ballast. Line the black wire up with the (-) and the tan wire up to the (+)

Low Beam connection

Factory Low beam connector

Ballast input wire



4. set the lights gently inside the headlight cove and bolt the lifting arm back to the motor. Once this is secure, connect the HID ballast output to the HID bulb in the projector and the OEM high beam connector to the High beam mini-harness already installed on your new housings.

ACA bi-xenon projector High beam wiring

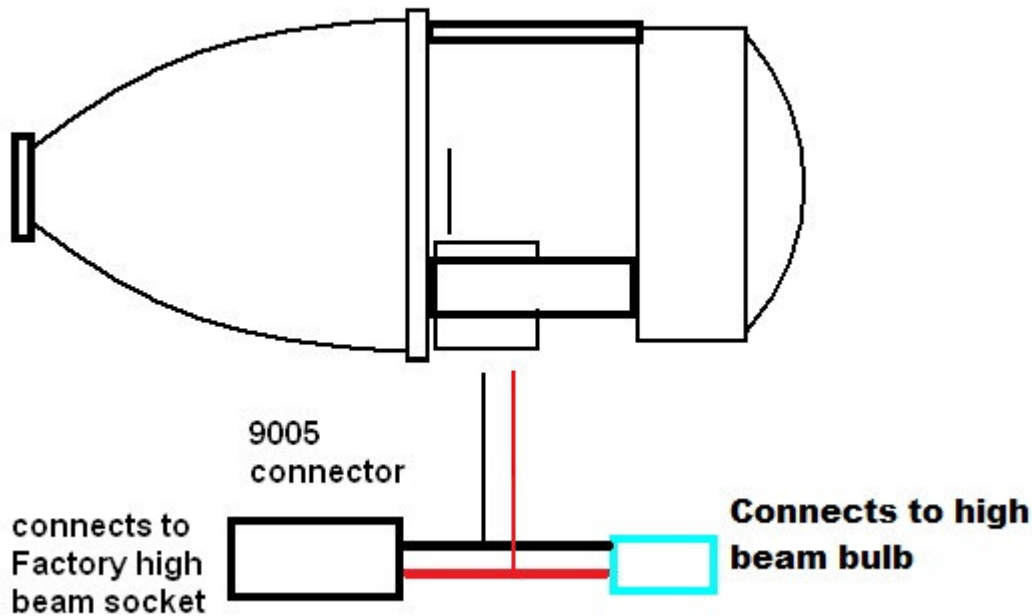

5. Re-install the Torx 20 screws, washers and nuts, then conduct a quick test of the headlights to verify all circuits have been wired correctly. Check your high beams as well. At this point, your projector will shut off in high beam mode, but your halogen high beams will turn on and you should be able to hear the bi-xenon solenoids activate with a "click" sound. (Full function will be established with the installation of the Hi-4 harness in phase 3)

6. Re-install the headlight cover and shroud:



Phase 3: Installation of your Hi-4 harness

1. Remove the cover of the under hood fuse box and note the positions of the fuses to be tapped.

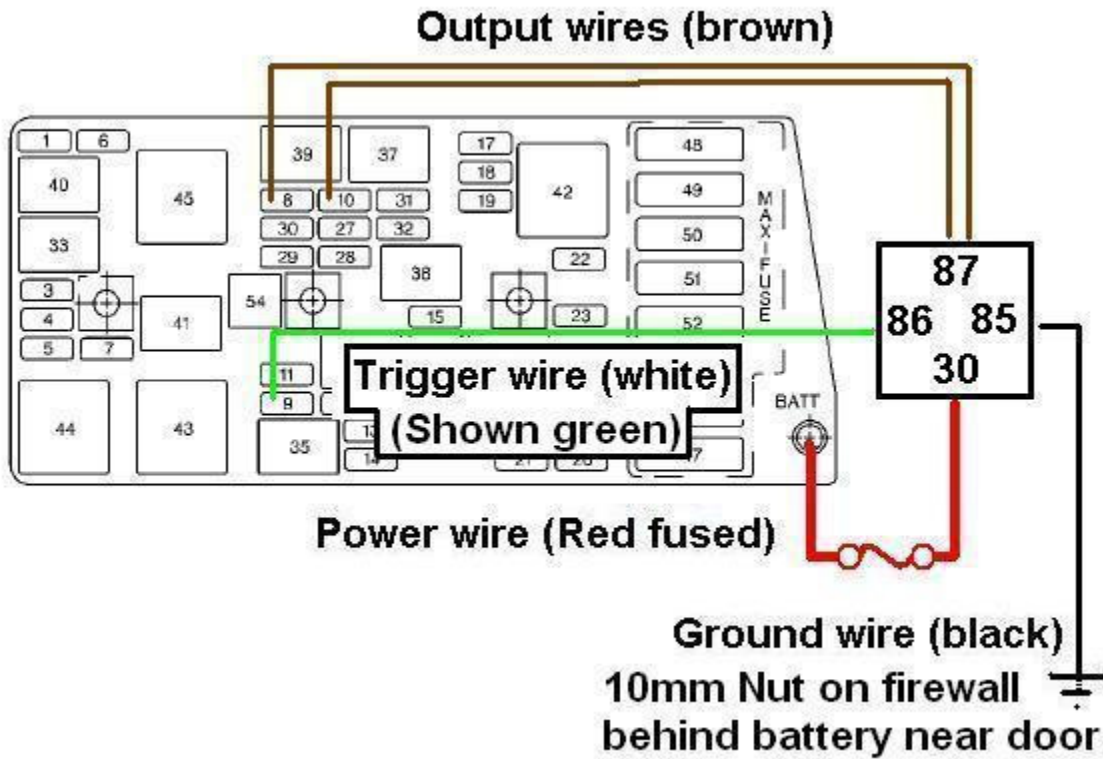

Tap the fuses as shown using the fuse taps supplied with your harness. The leg of the fuse will slide through the tap and back into the fuse socket. The fuse may not seat completely, but as long as you have good contact it will work as



intended. Fuse taps install like so:

Once installed, test your lights again to ensure full function. Your low beams should remain lit when in high beam mode.

Phase 4 aiming.

Park your car on a level surface 15-20 feet away from a wall (preferably a white or light colored wall) You may need painter's/masking tape and a tape measure as well.

Vertical aiming is the most important as this will keep from blinding oncoming traffic and provide you with safe distance sight at night. The lower (left) portion of the cutoff should be between 22 and 24" for a stock ride-height car. Lowered cars should be 21-22" from the ground.

Horizontal aiming is a bit more subjective. I prefer the "step" in the cutoff pattern to shoot directly in front of each headlight roughly the width of the car. This way, the steps (which are the most intense part of the beam pattern) remain parallel down the road and never cross. This adjustment may need to be done several times to get it perfect and you'll know after you've driven the car at night for a while.

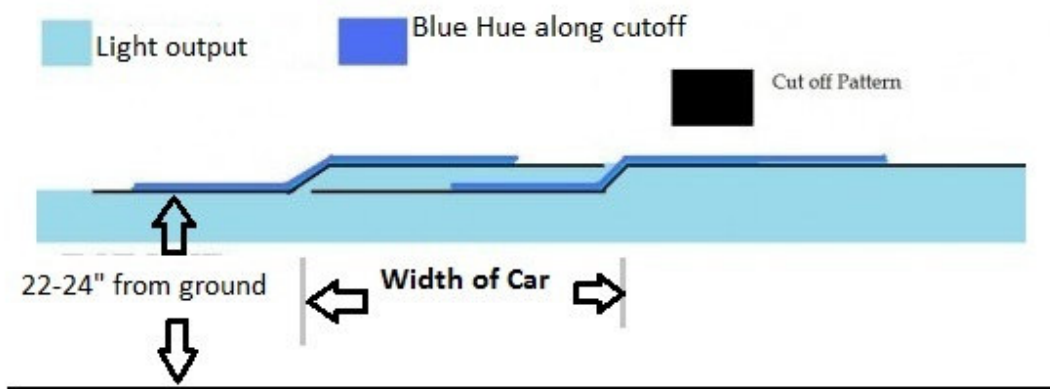

The pattern should look like this when you're finished:



If you have any questions, please let me know: Radioflyer97@gmail.com