

Corvette Personal Audio Link (PAL) for Vehicles Equipped with Factory Navigation Radio (U3U)

Special Note

Before beginning the installation process, please confirm the following:

1. The vehicle has a Factory Installed Navigation Radio RPO = U3U.
2. The radio has the latest software available.
3. If possible have an iPod available for testing.

NOTE: Remove Negative Battery Terminal before beginning installation.

Kit Contains:

- Personal Audio Link (PAL) Module
- PAL T-Harness
- Template for iPod Harness Access
- iPod Connector
- Owner's Manual
- Installation Sheet
- Adhesion Promoter
- Cable Tie (3)

Tools Required:

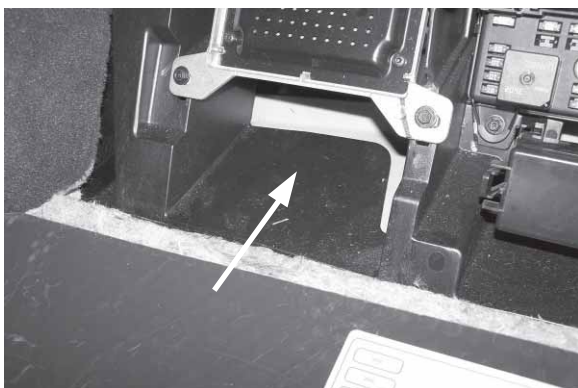
- Trim Removal Tool
- Drill with 13/16" Bit
- 7mm Nut Driver
- Wire removal tool

STEP 1 - Expose Front Floor Kick-Up Panel

Procedure

1. Pull inward on both sides of passenger toe board cover to access (I/P) fuse block.
2. Keep this area exposed for additional installation operations. Figure 1.

FIGURE 1



STEP 2 - Remove the Glove Box

Procedure

1. Detach the Tension Cable.
2. Apply inward force on both sides near tabs and pull down.
3. Carefully disengage (3) clamps from I/P rods. Remove outer tabs first, then remove inner flexible tab. Figure 2.

FIGURE 2



STEP 3 - Remove Parking Brake Boot

Procedure

1. Apply the parking brake.
2. Apply gentle upward force to front and rear of boot to release retention locks.
3. Slide boot up enough so it does not hinder removal of I/P trim. Figure 3.

FIGURE 3



Personal Audio Link (PAL)

IR23JN08

PART NO.

19201501

SHEET

1

OF **21**

ALL INFORMATION WITHIN ABOVE BORDER TO BE PRINTED EXACTLY AS SHOWN ON 8.5x11 WHITE 16 POUND NON-BOND RECYCLABLE PAPER. PRINT ON BOTH SIDES, EXCLUDING TEMPLATES. TO BE INITIALIZED IN ACCORDANCE WITH GMSPO SPECIFICATIONS.

DATE	REVISION	AUTH	DR
23JN08	Initial Release - Marvin Lewis		

TITLE			
INSTALLATION INSTRUCTIONS Personal Audio Link (PAL)			
PART NO.	SHEET	OF	
19201501	1	OF	21

STEP 4 - Remove Side Panel Accessory Trim Plate Procedure

- Using a 7mm socket, remove the (2) fasteners located under the parking brake. Figure 4 and 5.

FIGURE 4



FIGURE 5



STEP 5 - Remove Center Trim Panel Accessory Trim Plate Procedure

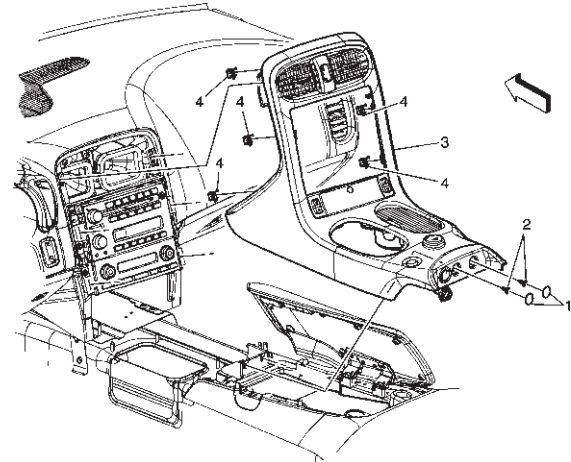
- Using a 7mm socket, remove the (2) fasteners located under Front Floor Console Compartment. Figure 6.

FIGURE 6



- Grasp the back edges of the trim and lift upward and rearward releasing the clips.
- Disengage enough to allow removal of the console trim electrical connectors.
- Adjust the shift lever position as necessary in order to remove the accessory trim plate from the vehicle.
- Remove the center console trim piece. Figure 7.

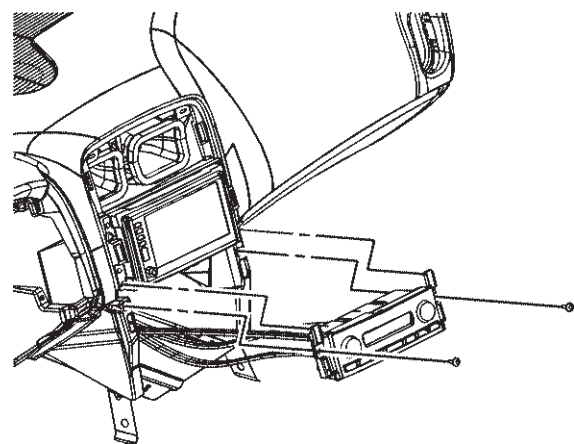
FIGURE 7



STEP 6 - Remove HVAC Control Module Procedure

- Using a 7mm socket, remove the HVAC control module retaining screws.
- Disconnect the HVAC control module electrical connections.
- Remove the HVAC control module. Figure 8.

FIGURE 8



Personal Audio Link (PAL)

IR23JN08

PART NO.

19201501

SHEET **2** OF **21**

ALL INFORMATION WITHIN ABOVE BORDER TO BE PRINTED EXACTLY AS SHOWN ON 8.5x11 WHITE 16 POUND NON-BOND RECYCLABLE PAPER. PRINT ON BOTH SIDES, EXCLUDING TEMPLATES. TO BE INITIALIZED IN ACCORDANCE WITH GMSPO SPECIFICATIONS.

DATE	REVISION	AUTH	DR

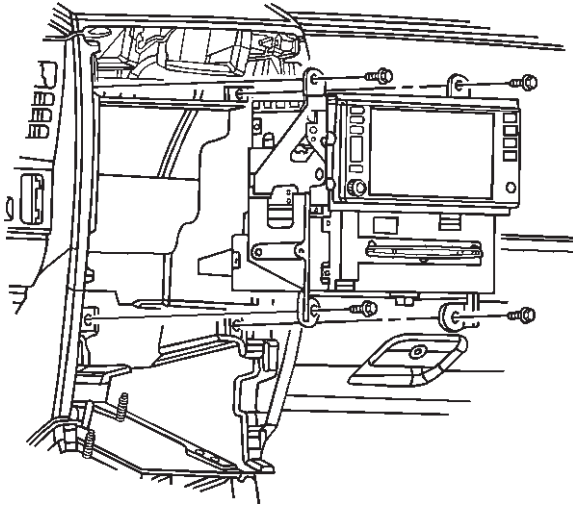
TITLE	
INSTALLATION INSTRUCTIONS Personal Audio Link (PAL)	
PART NO.	19201501
SHEET	2 OF 21

STEP 7 - Remove the Navigation Radio

Procedure

1. Remove the screws retaining the radio to the I/P center support bracket.
2. Remove the radio control from the center support bracket enough to access the connectors at the rear of the radio head unit.
3. Disconnect the electrical/audio and coaxial cable connectors from the radio control.
4. Remove the Navigation Radio. Figure 9.

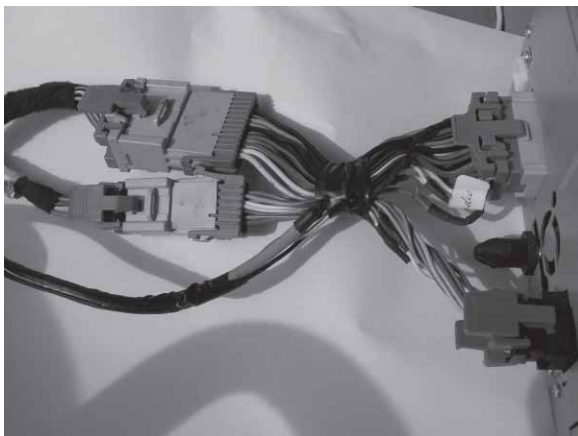
FIGURE 9



STEP 8 - Install and Route T-Harness into Navigation Radio I/P Harness

1. Install T-Harness between vehicle harness and radio as shown in Figure 10.
2. Reconnect XM, AM/FM and GPS antenna wires to the back of the radio.

FIGURE 10



Procedure

2. Unwrap the single class 2 wire and begin routing point at lower left side of the center console heating duct. Route wire down towards the floor of the vehicle. Figure 11.

FIGURE 11



3. Pull all excess wire down towards floor in preparation to route wire behind driver knee bolster. Figure 12.

FIGURE 12

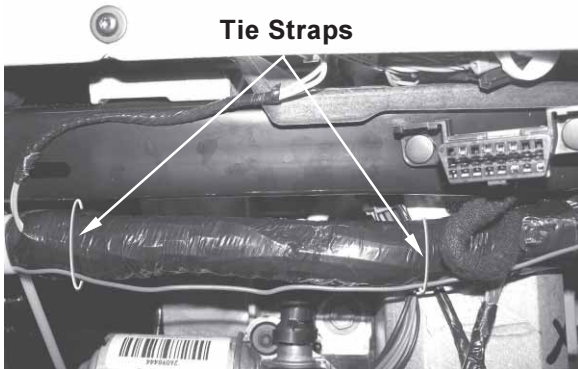


DATE	REVISION	AUTH	DR

Lower the I/P Lower Closeout Panel

4. Locate the I/P harness behind the driver knee bolster panel and route single Class 2 wire along side the IP harness. Install tie straps as shown. Figure 13 and Figure 14.

FIGURE 13



Continue routing wire to driver side terminal-splice pack.

FIGURE 14



**NOTE! PIN-K MUST BE COMPLETELY REMOVED.
NO WIRES GO BACK INTO PIN-K CAVITY.**

5. Remove Pin-K from the terminal-splice pack connector and cut the terminal off and expose the bare wire to prepare for the crimping operation. After Pin-K is removed, the splice pack comb and tape may be re-installed. Figure 15, Figure 16, Figure 17 and Figure 18.

FIGURE 15

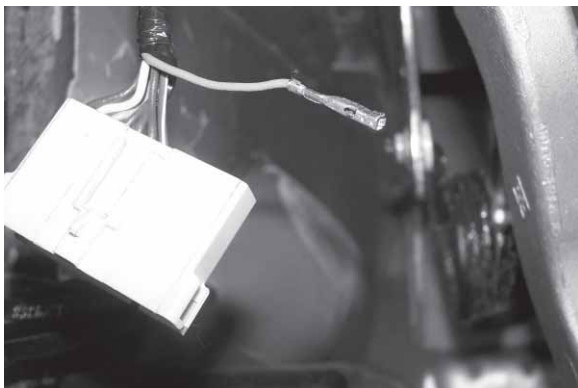
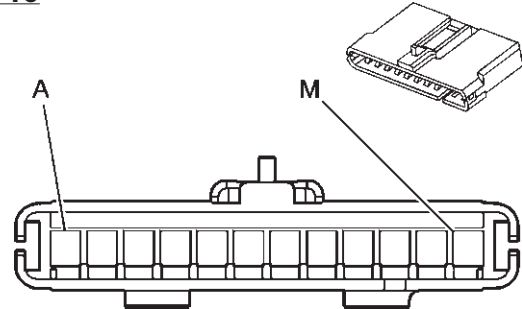


FIGURE 16

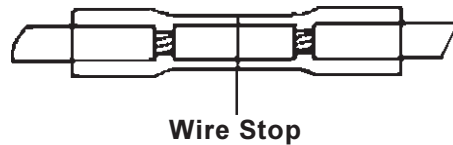


6. Take the single PAL harness wire that was pulled through the I/P and Crimp to the wire that was removed from Pin-K.

FIGURE 17

Sealed Splice Instructions:

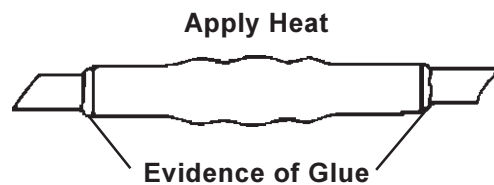
- A. Position stripped ends of wire into sleeve until wire hits stops.



- B. Hand crimp each side of the sleeve separately using the approved crimping tool (GM part number 12085115). Gently tug on the wires to make sure they are securely crimped.



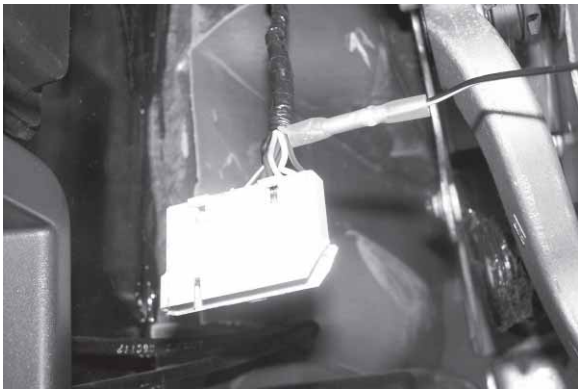
- C. Apply heat carefully to shrink the tubing. Use a heat gun or GM Ultra Torch (GM part number 12085116).



- D. Check for electrical continuity.

DATE	REVISION	AUTH	DR

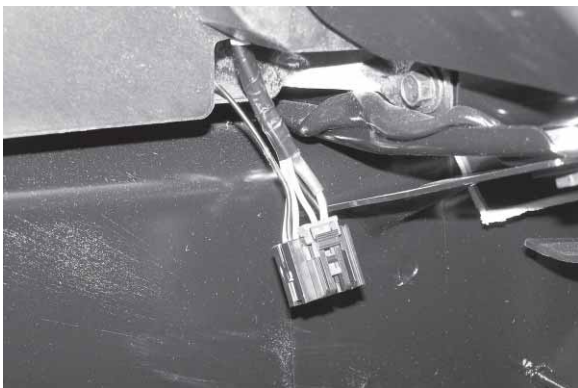
FIGURE 18



- Take 16-Pin wire harness and feed through opening located near lower left corner of glove box. Figure 19.

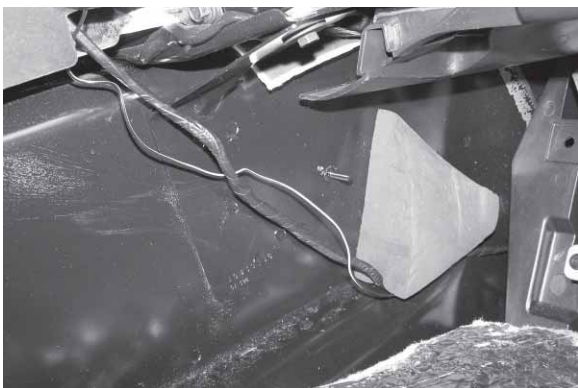
NOTE: USE CAUTION WHEN WIRE COULD CONTACT ANY SHARP EDGES.

FIGURE 19



- Route 16-Pin PAL harness wire down the side of center console and tuck under the foam block. Figure 20.

FIGURE 20



- Continue routing behind plastic electrical panel and leave enough excess wire to attach module in a later step. Figure 21.

FIGURE 21



STEP 9 - Mount iPod Cable to Glove Box

Procedure

- Place template on lower left corner outside area of glove box and drill a hole using a 13/16 drill bit. Figure 22.

FIGURE 22



Line Up Here

- Insert iPod connector from inside glove box. Figure 23.

FIGURE 23



Personal Audio Link (PAL)

IR23JN08

PART NO.

19201501

SHEET **5** OF **21**

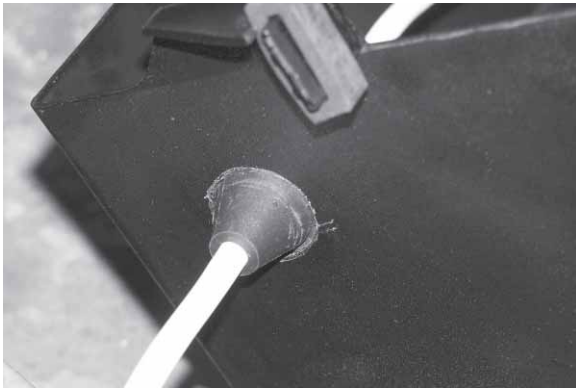
ALL INFORMATION WITHIN ABOVE BORDER TO BE PRINTED EXACTLY AS SHOWN ON 8.5x11 WHITE 16 POUND NON-BOND RECYCLABLE PAPER. PRINT ON BOTH SIDES, EXCLUDING TEMPLATES. TO BE UNITIZED IN ACCORDANCE WITH GMSPO SPECIFICATIONS.

DATE	REVISION	AUTH	DR

TITLE	
INSTALLATION INSTRUCTIONS Personal Audio Link (PAL)	
PART NO.	19201501
SHEET	5 OF 21

3. Pull iPod connector through and seat grommet into hole. Figure 24.

FIGURE 24

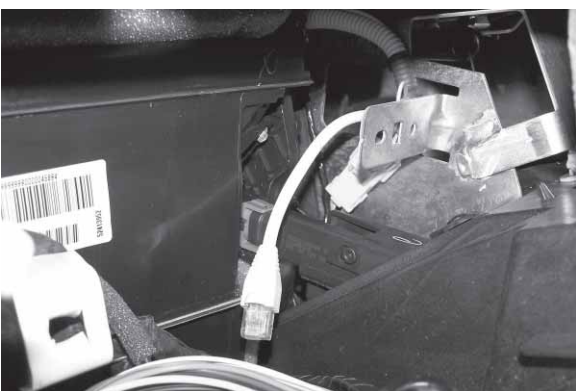


4. Route iPod connector through rectangular opening inside glove box cavity on I/P. Figure 25 and Figure 26.

FIGURE 25

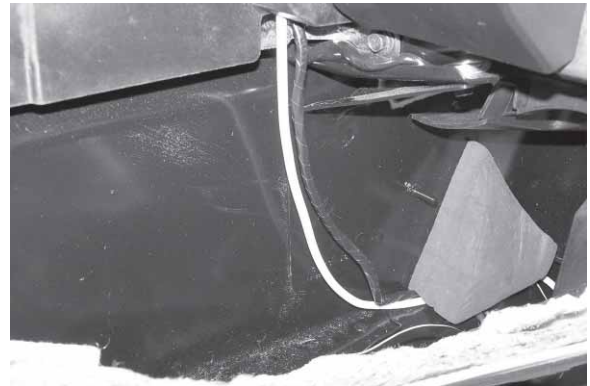


FIGURE 26



5. Route iPod connector through opening where lower corner of center console meets lower left side of glove box area and route iPod connector down the side of center console and tuck under the foam block. Figure 27.

FIGURE 27



6. Continue routing behind plastic panel and leave enough excess wire to attach module in a later step. Figure 28.

FIGURE 28



STEP 10 - Install Glove Box

Procedure

1. Pull excess iPod connector through and leave enough slack to allow for opening and closing of glove box. Figure 29.

FIGURE 29



Personal Audio Link (PAL)

IR23JN08

PART NO.

19201501

SHEET **6** OF **21**

ALL INFORMATION WITHIN ABOVE BORDER TO BE PRINTED EXACTLY AS SHOWN ON 8.5x11 WHITE 16 POUND NON-BOND RECYCLABLE PAPER. PRINT ON BOTH SIDES, EXCLUDING TEMPLATES. TO BE UNITIZED IN ACCORDANCE WITH GMSPO SPECIFICATIONS.

DATE	REVISION	AUTH	DR

INSTALLATION INSTRUCTIONS	
Personal Audio Link (PAL)	
PART NO.	SHEET 6 OF 21
19201501	

2. Re-install glove box. Figure 30.

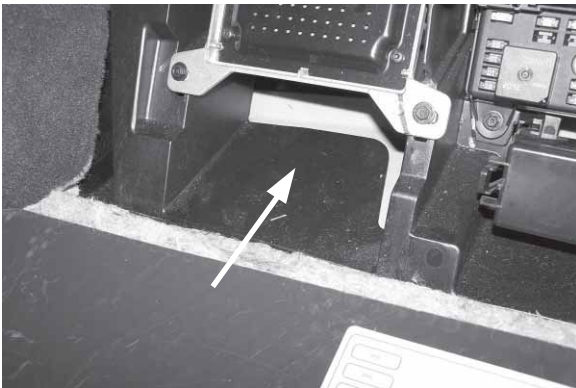
FIGURE 30



STEP 11 - Module Mounting Preparation

1. Clean mounting area with adhesion promoter. Figure 31.

FIGURE 31



2. Plug both connectors into PAL module. Figure 32.

FIGURE 32



3. Remove adhesive strip from bottom of PAL module and position module as shown with iPod cable facing forward in vehicle and the 16-pin connector facing the rear of vehicle. Make sure that module or harness does not protrude past plastic bracket so that the floor carpet will seat correctly. Figure 33.

FIGURE 33



STEP 12 - Re-install Vehicle Components

- Front Floor Kick-Up Panel
- HVAC Unit
- Navigation Radio
- Trim Plate
- Parking Brake Lever Boot
- Center Trim Panel
- Passenger Side Center Trim Carpet
- Close Out Panel
- Connect Negative Battery Terminal
- Accessory Trim Plate

STEP 13 - Final Quick Device Check

1. If no iPod is connected you will see "No iPod" when you press the XM2 band soft key.
2. If an iPod is available, then after connecting the iPod and having the ignition on, press the XM2 band soft key and then the iPod User Interface Screen should appear.

Personal Audio Link (PAL)

IR23JN08

PART NO.

19201501

SHEET

7

OF **21**

ALL INFORMATION WITHIN ABOVE BORDER TO BE PRINTED EXACTLY AS SHOWN ON 8.5x11 WHITE 16 POUND NON-BOND RECYCLABLE PAPER. PRINT ON BOTH SIDES, EXCLUDING TEMPLATES. TO BE UNITIZED IN ACCORDANCE WITH GMSPO SPECIFICATIONS.

DATE	REVISION	AUTH	DR

INSTALLATION INSTRUCTIONS	
Personal Audio Link (PAL)	
PART NO.	19201501
SHEET	7 OF 21

Corvette - Module PAL (Personal Audio Link) pour véhicules équipés de la radio de navigation d'origine (U3U)

Remarque spéciale

Avant d'entamer le processus d'installation, prière de confirmer les points suivants :

1. Le véhicule est équipé de la radio de navigation d'origine EFC = U3U.
2. La radio dispose du plus récent logiciel.
3. Si possible, avoir en mains un iPod aux fins d'essai.

NOTA : Débrancher le câble négatif de la batterie avant de débiter l'installation.

Contenu de la trousse :

- Module PAL (Personal Audio Link)
- Faisceau de câblage en T pour module PAL
- Gabarit pour accès au faisceau de câblage pour iPod
- Connecteur pour iPod
- Guide du propriétaire
- Feuillet d'installation
- Accélérateur d'adhérence
- Colliers d'attache (3)

Outils nécessaires :

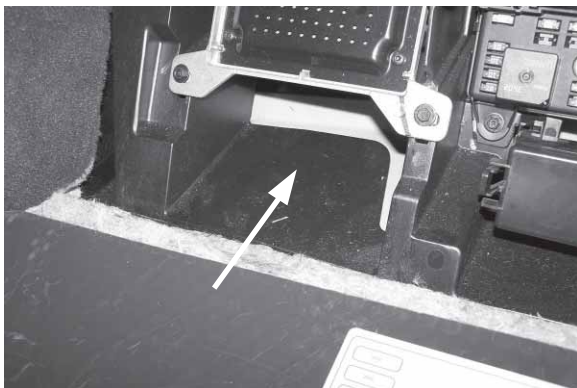
- Outil de dépose de garniture
- Perceuse avec foret de 13/16 po
- Tournevis à douille de 7 mm
- Outil de débranchement de connecteur

ÉTAPE 1 – Accès au panneau de seuil de plancher avant

Procédure

1. Appliquer une pression vers l'intérieur sur les deux côtés du couvercle de panneau antérieur de l'espace pour les jambes du côté passager pour accéder au bloc-fusibles.
2. Garder cet espace ouvert en vue d'opérations subséquentes au cours de l'installation. Figure 1.

FIGURE 1



ÉTAPE 2 – Retrait de la boîte à gants

Procédure

1. Détacher le câble de tension.
2. Appliquer une pression vers l'intérieur des deux côtés, près des pattes de retenue, puis tirer vers le bas.
3. Libérer les attaches (3) des tringles du tableau de bord. Retirer d'abord la patte extérieure, puis la patte flexible intérieure. Figure 2.

FIGURE 2



ÉTAPE 3 – Retrait du soufflet du levier de frein de stationnement

Procédure

1. Serrer le frein de stationnement.
2. Appliquer une légère pression vers le haut à l'avant et à l'arrière du soufflet pour libérer les attaches.
3. Glisser le soufflet vers le haut juste assez pour ne pas gêner la dépose du panneau de garniture de tableau de bord. Figure 3.

FIGURE 3



Personal Audio Link (PAL)

IR23JN08

PART NO.

19201501

SHEET **8**

OF **21**

ALL INFORMATION WITHIN ABOVE BORDER TO BE PRINTED EXACTLY AS SHOWN ON 8.5x11 WHITE 16 POUND NON-BOND RECYCLABLE PAPER. PRINT ON BOTH SIDES, EXCLUDING TEMPLATES. TO BE UNITIZED IN ACCORDANCE WITH GMSPO SPECIFICATIONS.

DATE	REVISION	AUTH	DR

TITLE	
INSTALLATION INSTRUCTIONS Personal Audio Link (PAL)	
PART NO.	19201501
SHEET	8
OF	21

ÉTAPE 4 – Retrait du panneau de garniture latéral des accessoires

Procédure

1. À l'aide d'une douille de 7 mm, retirer les fixations (2) situées sous le levier de frein de stationnement. Figures 4 et 5.

FIGURE 4



FIGURE 5



ÉTAPE 5 – Retrait du panneau de garniture central des accessoires

Procédure

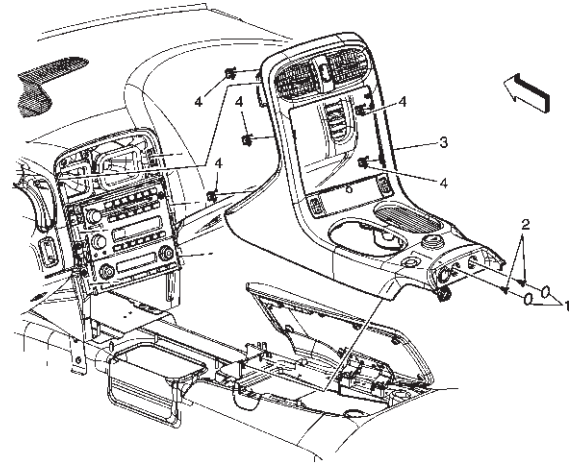
1. À l'aide d'une douille de 7 mm, retirer les fixations (2) situées sous le compartiment de la console de plancher avant. Figure 6.

FIGURE 6



2. Saisir les rebords arrière de la garniture et pousser vers le haut puis vers l'arrière pour libérer les agrafes.
3. Soulever suffisamment pour pouvoir retirer les connecteurs électriques de la garniture de la console.
4. Au besoin, déplacer le levier sélecteur afin de pouvoir retirer le panneau de garniture des accessoires.
5. Retirer la garniture de la console centrale. Figure 7.

FIGURE 7

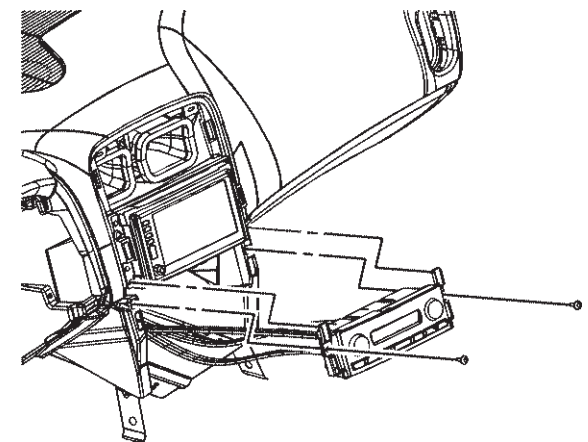


ÉTAPE 6 – Retrait du module de commande de CVC

Procédure

1. À l'aide d'une douille de 7 mm, retirer les vis de fixation du module de commande de CVC.
2. Débrancher le connecteur électrique du module de commande de CVC.
3. Retirer le module de commande de CVC. Figure 8.

FIGURE 8



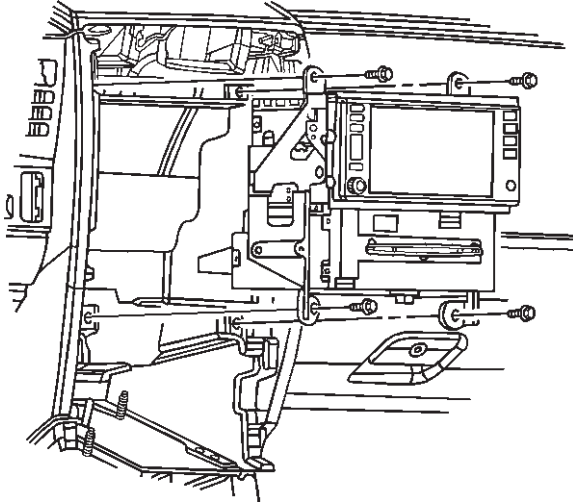
DATE	REVISION	AUTH	DR

ÉTAPE 7 – Retrait de la radio de navigation

Procédure

1. Retirer les vis fixant la radio au support central de tableau de bord.
2. Éloigner suffisamment la radio du support central pour pouvoir accéder aux connecteurs qui se trouvent à l'arrière de la radio.
3. Débrancher les connecteurs des câbles électrique, audio et coaxial de la radio.
4. Retirer la radio de navigation. Figure 9.

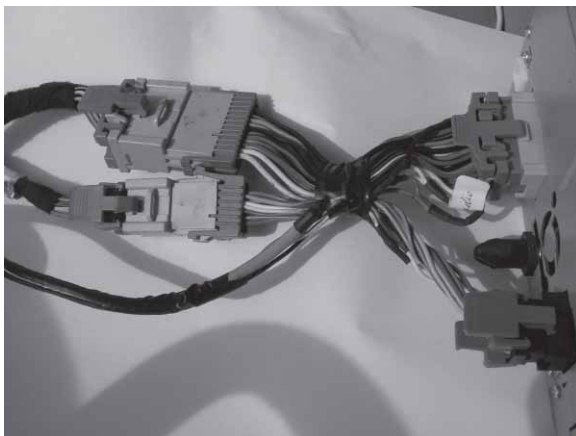
FIGURE 9



ÉTAPE 8 – Branchement du faisceau en T au faisceau de tableau de bord de la radio de navigation et cheminement du faisceau

1. Installer le faisceau en T entre le faisceau du véhicule et la radio tel qu'indiqué à la figure 10.
2. Rebrancher les câbles des antennes XM, AM-FM et GPS à l'arrière de la radio.

FIGURE 10



Procédure

2. Déballez le fil simple de classe 2 et commencez la pose dans le coin inférieur gauche du conduit de chauffage de la console centrale. Diriger ensuite le fil vers le plancher du véhicule. Figure 11.

FIGURE 11



3. Tirer toute longueur excédentaire du fil vers le plancher en vue de le diriger derrière le protège-genoux du conducteur. Figure 12.

FIGURE 12



Personal Audio Link (PAL)

IR23JN08

PART NO.

19201501

SHEET

10 OF 21

ALL INFORMATION WITHIN ABOVE BORDER TO BE PRINTED EXACTLY AS SHOWN ON 8.5x11 WHITE 16 POUND NON-BOND RECYCLABLE PAPER. PRINT ON BOTH SIDES, EXCLUDING TEMPLATES. TO BE INITIALIZED IN ACCORDANCE WITH GMSPO SPECIFICATIONS.

DATE	REVISION	AUTH	DR

INSTALLATION INSTRUCTIONS	
Personal Audio Link (PAL)	
PART NO.	19201501
SHEET	10 OF 21

Abaisser le panneau de fermeture inférieur du tableau de bord

- Repérer le faisceau de tableau de bord situé derrière le protège-genoux du conducteur et fixer le fil simple de classe 2 le long du faisceau de tableau de bord. Utiliser des colliers d'attache tel que montré. Figures 13 et 14.

FIGURE 13 Collier d'attaches



Amener ensuite le fil jusqu'au bloc de raccordement du côté conducteur.

FIGURE 14



REMARQUE ! LE FIL PROVENANT DE L'ALVÉOLE « PIN-K » DOIT ÊTRE COMPLÈTEMENT RETIRÉ.

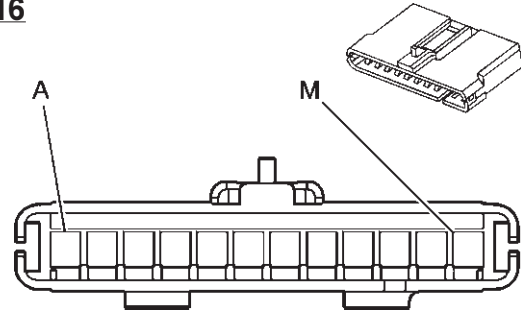
AUCUN AUTRE FIL NE DOIT ÊTRE INSÉRÉ DANS L'ALVÉOLE « PIN-K ».

- Extraire le fil « Pin-K » du connecteur du bloc de raccordement, couper la borne et dénuder le fil en vue du sertissage. Une fois le fil « Pin-K » retiré, remettre en place le peigne du bloc de raccordement et appliquer du ruban isolant. Figures 15, 16, 17 et 18.

FIGURE 15



FIGURE 16

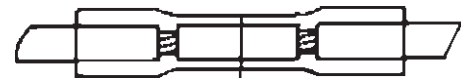


- Sertir ensuite le fil simple PAL amené précédemment à travers le tableau de bord au fil « Pin-K » provenant du connecteur.

FIGURE 17

Instructions pour la réalisation d'un connecteur bout à bout étanche

- Insérer jusqu'en butée les extrémités dénudées des fils dans le connecteur bout à bout.



Butée de fil

- Sertir séparément à la main chaque côté du connecteur au moyen d'une pince à sertir approuvée (numéro de pièce GM 12085115). Tirer doucement sur les fils pour s'assurer qu'ils sont solidement sertis.



Sertissage

- Chauffer avec soin la gaine thermorétractable. Utiliser un pistolet thermique ou l'outil UltraTorch de GM (numéro de pièce GM 12085116).

Application de chaleur



Présence de colle

- Vérifier la continuité électrique.

Personal Audio Link (PAL)

IR23JN08

PART NO.

19201501

SHEET

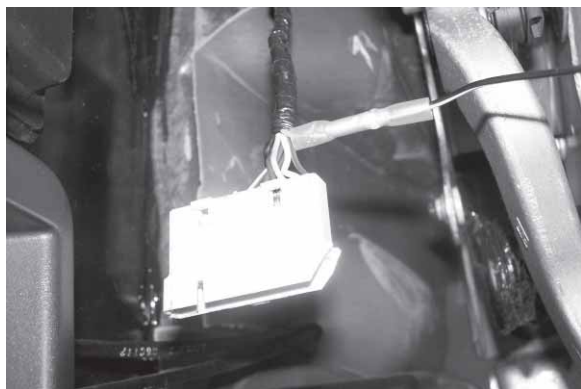
11 OF 21

ALL INFORMATION WITHIN ABOVE BORDER TO BE PRINTED EXACTLY AS SHOWN ON 8.5x11 WHITE 16 POUND NON-BOND RECYCLABLE PAPER. PRINT ON BOTH SIDES, EXCLUDING TEMPLATES. TO BE UNITIZED IN ACCORDANCE WITH GMSPO SPECIFICATIONS.

DATE	REVISION	AUTH	DR

TITLE	
INSTALLATION INSTRUCTIONS Personal Audio Link (PAL)	
PART NO.	19201501
SHEET	11 OF 21

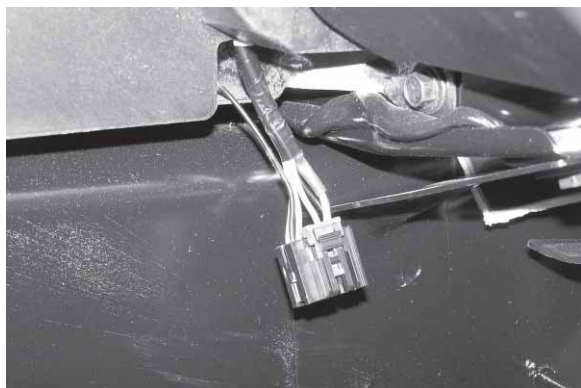
FIGURE 18



7. Glisser le faisceau de câblage du connecteur à 16 broches par l'ouverture située près du coin inférieur gauche de la boîte à gants. Figure 19.

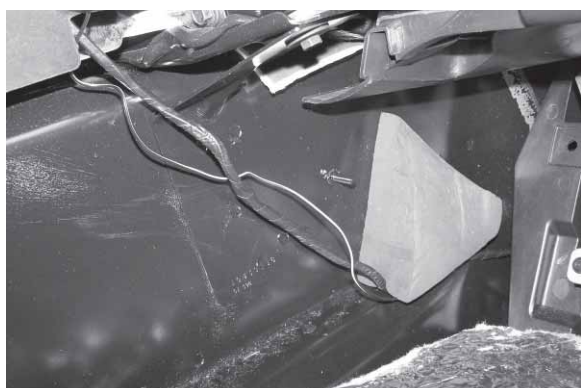
NOTA : PRENDRE LES PRÉCAUTIONS D'USAGE POUR ÉVITER QUE LE FAISCEAU DE CÂBLAGE NE S'APPUIE SUR UNE ARÊTE VIVE

FIGURE 19



8. Diriger le faisceau de câblage du connecteur à 16 broches PAL sur le côté de la console centrale et le loger sous le bloc en mousse. Figure 20.

FIGURE 20



9. Amener ensuite le faisceau derrière le panneau électrique de plastique et laisser suffisamment de câble pour y brancher le module à une étape ultérieure. Figure 21.

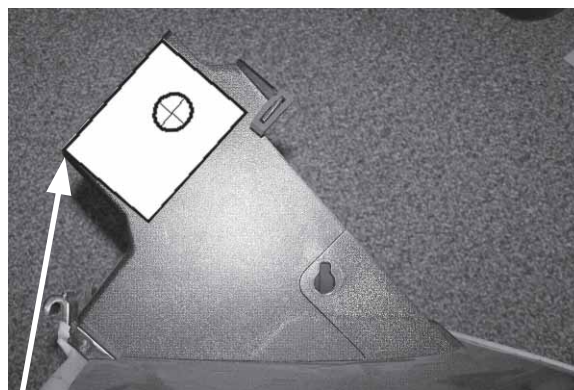
FIGURE 21



ÉTAPE 9 – Fixation du câble du iPod à la boîte à gants
Procédure

1. Placer le gabarit sur la face extérieure du coin inférieur gauche de la boîte à gants et percer un trou à l'aide du foret de 13/16 po. Figure 22.

FIGURE 22



Alignement du gabarit

2. Par l'intérieur de la boîte à gants, glisser le câble de l'iPod dans le trou. Figure 23.

FIGURE 23



Personal Audio Link (PAL)

IR23JN08

PART NO.

19201501

SHEET

12 OF 21

ALL INFORMATION WITHIN ABOVE BORDER TO BE PRINTED EXACTLY AS SHOWN ON 8.5x11 WHITE 16 POUND NON-BOND RECYCLABLE PAPER. PRINT ON BOTH SIDES, EXCLUDING TEMPLATES. TO BE INITIALIZED IN ACCORDANCE WITH GMSPO SPECIFICATIONS.

DATE	REVISION	AUTH	DR

TITLE	
INSTALLATION INSTRUCTIONS Personal Audio Link (PAL)	
PART NO.	19201501
SHEET	12 OF 21

3. Tirer sur le connecteur du iPod et loger la bague dans le trou. Figure 24.

FIGURE 24



4. Diriger le connecteur du iPod dans l'ouverture rectangulaire à l'intérieur de l'évidement de la boîte à gants sur le tableau de bord. Figures 25 et 26.

FIGURE 25

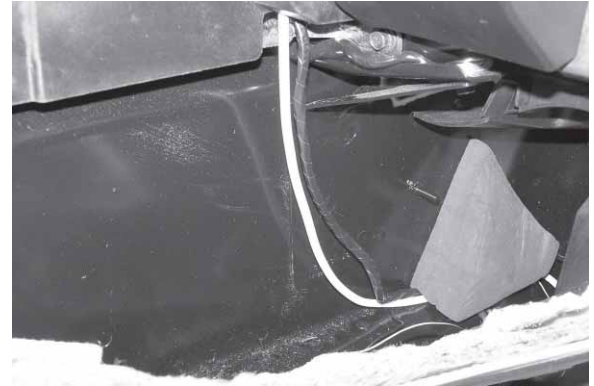


FIGURE 26



5. Diriger ensuite le connecteur du iPod dans l'ouverture située à l'endroit où le coin inférieur de la console centrale rencontre la partie inférieure gauche de la boîte à gants, puis vers le bas, sur le côté de la console centrale, puis jusque sous le bloc de mousse. Figure 27.

FIGURE 27



6. Poursuivre le cheminement derrière le panneau de plastique en laissant suffisamment de câble pour y brancher le module à une étape ultérieure. Figure 28.

FIGURE 28



ÉTAPE 10 – Pose de la boîte à gants

Procédure

1. Tirer pour réduire la longueur excédentaire du câble du iPod, en prenant soin de laisser suffisamment de câble pour permettre l'ouverture et la fermeture du volet de la boîte à gants. Figure 29.

FIGURE 29



Personal Audio Link (PAL)

IR23JN08

PART NO.

19201501

SHEET

13 OF 21

ALL INFORMATION WITHIN ABOVE BORDER TO BE PRINTED EXACTLY AS SHOWN ON 8.5x11 WHITE 16 POUND NON-BOND RECYCLABLE PAPER. PRINT ON BOTH SIDES, EXCLUDING TEMPLATES. TO BE UNITIZED IN ACCORDANCE WITH GMSPO SPECIFICATIONS.

DATE	REVISION	AUTH	DR

TITLE	
INSTALLATION INSTRUCTIONS Personal Audio Link (PAL)	
PART NO.	19201501
SHEET	13 OF 21

2. Remettre la boîte à gants en place. Figure 30.

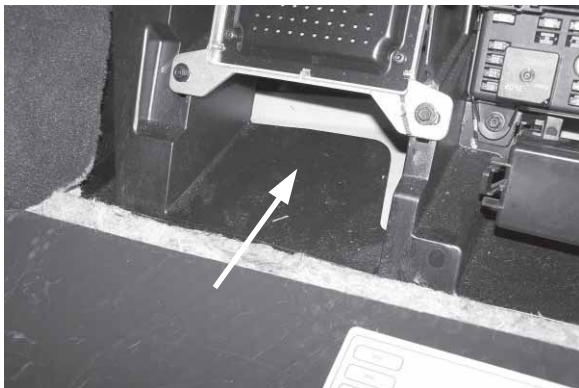
FIGURE 30



ÉTAPE 11 – Préparation au montage du module

1. Nettoyer la surface de montage au moyen d'un accélérateur d'adhérence. Figure 31.

FIGURE 31



2. Brancher les deux connecteurs au module PAL. Figure 32.

FIGURE 32



3. Retirer la protection de la bande adhésive sous le module PAL et positionner le module tel que montré, de façon que le câble de l'iPod soit orienté vers l'avant du véhicule et le connecteur à 16 broches vers l'arrière du véhicule. S'assurer que le module ou le faisceau de câblage ne dépasse pas du support de plastique, ce qui empêcherait la moquette de sol de se placer correctement. Figure 33.

FIGURE 33



ÉTAPE 12 – Remise en place des composants du véhicule

- Panneau de seuil de plancher avant
- Module de commande de CVC
- Radio de navigation
- Panneau de garniture
- Soufflet de levier de frein de stationnement
- Panneau de garniture central
- Tapis de garnissage central du côté passager
- Panneau de fermeture
- Branchement du câble négatif de la batterie
- Panneau de garniture des accessoires

ÉTAPE 13 – Contrôle final de fonctionnement du dispositif

1. Si aucun iPod n'est raccordé au système, l'écran affiche « No iPod » (pas de iPod) lorsque la touche programmable XM2 est enfoncée.
2. Lorsqu'un iPod est raccordé au système et que le contact est établi, l'écran d'interface de l'iPod de l'utilisateur s'affiche lorsque la touche programmable XM2 est enfoncée.

Personal Audio Link (PAL)

IR23JN08

PART NO.

19201501

SHEET

14 OF 21

ALL INFORMATION WITHIN ABOVE BORDER TO BE PRINTED EXACTLY AS SHOWN ON 8.5x11 WHITE 16 POUND NON-BOND RECYCLABLE PAPER. PRINT ON BOTH SIDES, EXCLUDING TEMPLATES. TO BE UNITIZED IN ACCORDANCE WITH GMSPO SPECIFICATIONS.

DATE	REVISION	AUTH	DR

TITLE	
INSTALLATION INSTRUCTIONS Personal Audio Link (PAL)	
PART NO.	19201501
SHEET	14 OF 21

Conexión de audio personal (PAL) de Corvette para vehículos equipados con Radio de navegación de fábrica (U3U)

Nota especial

Antes de empezar el proceso de instalación, verifique lo siguiente:

1. El vehículo tiene un radio de navegación instalado de fábrica RPO = U3U.
2. El radio tiene el software más reciente disponible.
3. Si fuera posible, tenga un iPod disponible para realizar la prueba.

NOTA: Retire el borne negativo de la batería antes de comenzar la instalación.

El kit contiene:

- Módulo de conexión de audio personal (PAL)
- Arnés T de PAL
- Plantilla para el acceso al arnés del iPod
- Conector de iPod
- Manual del propietario
- Hoja de instalación
- Activador de adhesión
- Amarre de cable (3)

Herramientas necesarias:

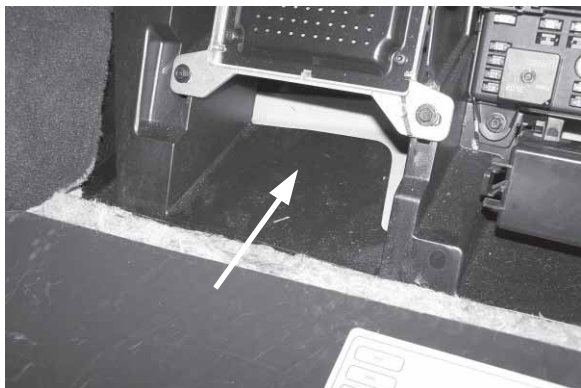
- Herramienta de desinstalación de acabado
- Barreno con broca de 13/16"
- Llave para tuercas de 7mm
- Herramienta de desinstalación de cable

PASO 1 – Deje expuesto el panel lateral inferior delantero del piso

Procedimiento

1. Jale hacia el interior ambos lados de la cubierta del tablero delantero del pasajero para obtener acceso al bloque de fusibles del (I/P).
2. Mantenga esta área expuesta para operaciones de instalación adicionales. Figura 1.

FIGURA 1



PASO 2 – Desinstale la guantera

Procedimiento

1. Libere el cable de tensión.
2. Aplique fuerza hacia adentro en ambos lados cerca de las lengüetas y baje.
3. Cuidadosamente desacople las (3) abrazaderas de las varillas del I/P. Retire las lengüetas exteriores de primero, luego retire la lengüeta flexible interior. Figura 2.

FIGURA 2



PASO 3 – Retire la cubierta del freno de estacionamiento

Procedimiento

1. Aplique el freno de estacionamiento
2. Aplique suavemente fuerza hacia arriba a la parte delantera y trasera de la cubierta para liberar los seguros de retención.
3. Deslice la cubierta hacia arriba lo suficiente para que no impida la desinstalación del acabado del I/P. Figura 3.

FIGURA 3



Personal Audio Link (PAL)

IR23JN08

PART NO.

19201501

SHEET

15 OF 21

ALL INFORMATION WITHIN ABOVE BORDER TO BE PRINTED EXACTLY AS SHOWN ON 8.5x11 WHITE 16 POUND NON-BOND RECYCLABLE PAPER. PRINT ON BOTH SIDES, EXCLUDING TEMPLATES. TO BE UNITIZED IN ACCORDANCE WITH GMSPO SPECIFICATIONS.

DATE	REVISION	AUTH	DR

INSTALLATION INSTRUCTIONS	
Personal Audio Link (PAL)	
PART NO.	19201501
SHEET	15 OF 21

PASO 4 - Desinstale la placa de acabado de accesorios del panel lateral

Procedimiento

1. Con una copa de 7mm, retire los (2) afianzadores ubicados debajo del freno de estacionamiento. Figura 4 y 5.

FIGURA 4



FIGURA 5



PASO 5 - Desinstale la placa de acabado de accesorios del panel de acabado central

Procedimiento

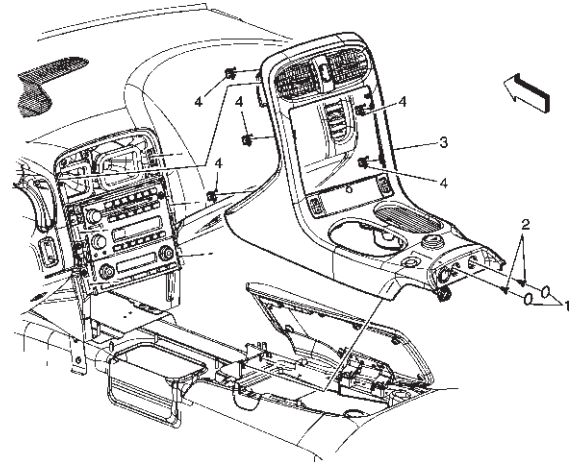
1. Con una copa de 7mm, retire los (2) afianzadores que se encuentran debajo del Compartimiento de la consola delantera del piso. Figura 6.

FIGURA 6



2. Sostenga los bordes traseros del acabado y levántelos hacia arriba y hacia atrás para liberar los sujetadores.
3. Desacople lo suficiente para permitir la desinstalación de los conectores eléctricos del acabado de la consola.
4. Ajuste la posición de la palanca de cambios como sea necesario a fin de retirar la placa de acabado de accesorios del vehículo.
5. Retire la pieza de acabado de la consola central. Figura 7.

FIGURA 7

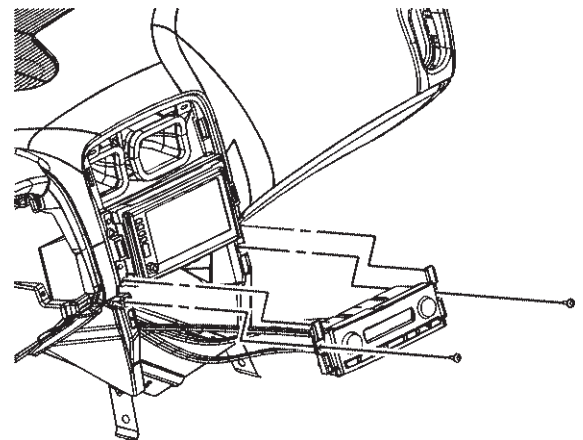


PASO 6 - Retire el módulo de control de HVAC

Procedimiento

1. Con una copa de 7mm, retire los tornillos de retención del módulo de control de HVAC.
2. Desconecte todas las conexiones eléctricas del módulo de control de HVAC.
3. Desinstale el módulo de control de HVAC. Figura 8.

FIGURA 8



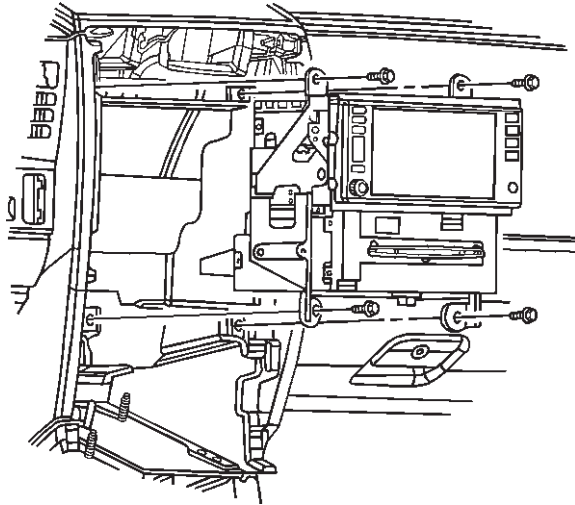
DATE	REVISION	AUTH	DR

PASO 7 – Desinstale el radio de navegación

Procedimiento

1. Retire los tornillos que retienen el radio al soporte central del I/P.
2. Retire el control del radio del soporte central lo suficiente para obtener acceso a los conectores en la parte trasera de la unidad superior del radio.
3. Desconecte los conectores del cable coaxial y eléctrico/audio del control del radio.
4. Retire el Radio de navegación. Figura 9.

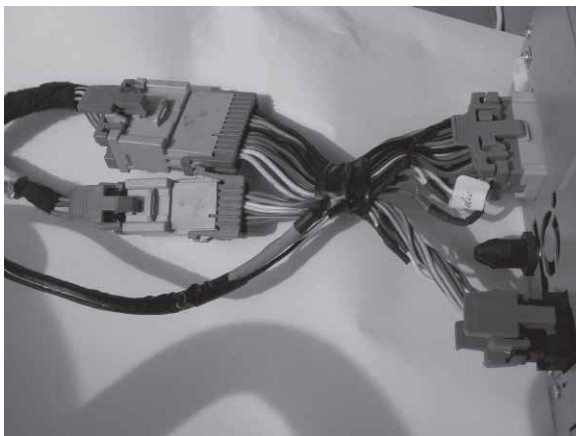
FIGURA 9



PASO 8 – Instale y enrute el arnés T en el arnés del I/P del radio de navegación

1. Instale el arnés T entre el arnés del vehículo y el radio tal y como se muestra en la Figura 10.
2. Vuelva a conectar los cables de la antena XM, AM/FM y GPS a la parte trasera del radio.

FIGURA 10



Procedimiento

2. Desenvuelva el cable 2 de clase única y comience el punto de enrutamiento en la parte inferior izquierda del ducto de calefacción de la consola central. Enrute el cable hacia el piso del vehículo. Figura 11.

FIGURA 11



3. Jale todo el exceso del cable hacia el piso para prepararse a enrutar el cable detrás del soporte para rodillas del conductor. Figura 12.

FIGURA 12



Personal Audio Link (PAL)

IR23JN08

PART NO.

19201501

SHEET

17 OF 21

ALL INFORMATION WITHIN ABOVE BORDER TO BE PRINTED EXACTLY AS SHOWN ON 8.5x11 WHITE 16 POUND NON-BOND RECYCLABLE PAPER. PRINT ON BOTH SIDES, EXCLUDING TEMPLATES. TO BE UNITIZED IN ACCORDANCE WITH GMSPO SPECIFICATIONS.

DATE	REVISION	AUTH	DR

TITLE

**INSTALLATION INSTRUCTIONS
Personal Audio Link (PAL)**

PART NO.

19201501

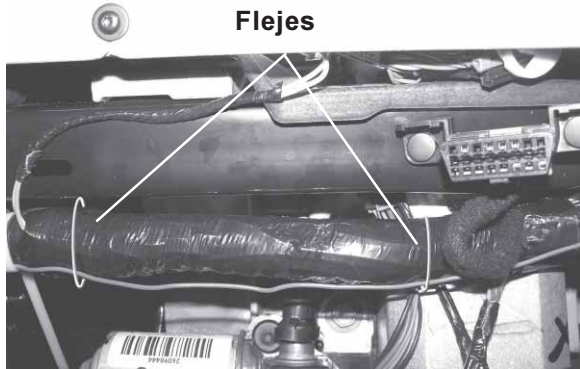
SHEET

17 OF 21

Baje el panel de cierre inferior del I/P

4. Ubique el arnés del I/P detrás del panel de soporte para rodillas del conductor y enrute el cable de clase 2 único a lo largo del arnés del IP. Instale los amarres tal y como se muestra. Figura 13 y Figura 14.

FIGURA 13



Continúe enrutando el cable al paquete de empalmes de terminales laterales.

FIGURA 14



¡NOTA! DEBE RETIRAR POR COMPLETO EL PASADOR K. NINGÚN CABLE REGRESA A LA CAVIDAD DEL PASADOR K.

5. Retire el pasador K del conector del paquete de empalmes de la terminal y corte la terminal y esponga el cable desnudo para prepararse para la operación de engarzado. Después de que retira el pasador K, debe volver a instalar el paquete de empalmes combinado y la cinta. Figura 15, Figura 16, Figura 17 y Figura 18.

FIGURA 15

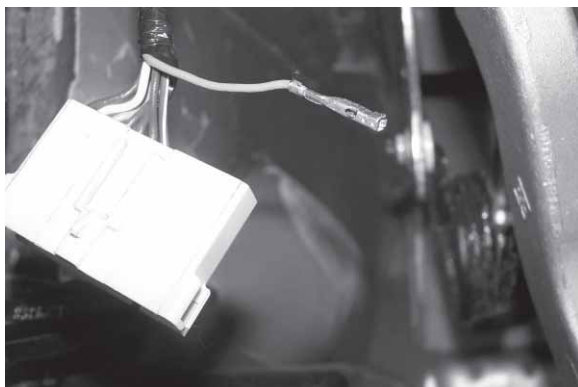
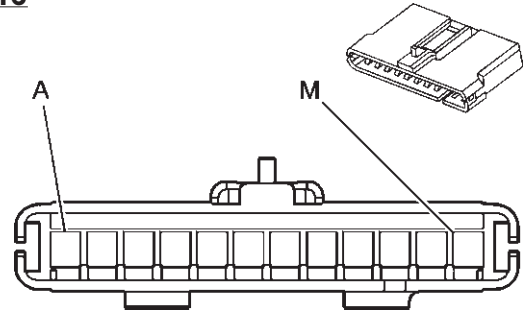


FIGURA 16

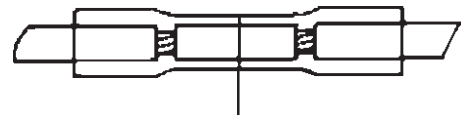


6. Tome el cable del arnés PAL único que se jaló a través del I/P y engarce al cable que se retiró del pasador K.

FIGURA 17

Instrucciones para un empalme sellado:

A. Coloque los extremos pelados del cable en el forro hasta que el cable llegue a los topes.



Tope de los cables

B. Engarce manualmente cada lado del foro por separado con la engarzadora aprobada (Número de parte 12085115 de GM). Jale cuidadosamente los cables para asegurarse de que quedaron bien engarzados.



Engarce

C. Cuidadosamente, aplique calor para encoger el tubo. Utilice una pistola de aire caliente o Ultra Torch de GM (Número de parte 12085116 de GM).

Aplique calor



Restos de adhesivo

D. Verifique que haya continuidad eléctrica.

Personal Audio Link (PAL)

IR23JN08

PART NO.

19201501

SHEET **18**

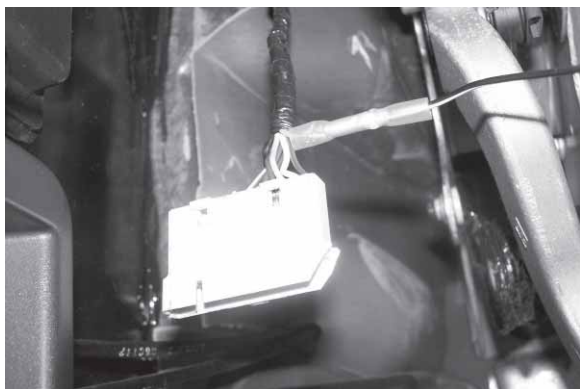
OF **21**

ALL INFORMATION WITHIN ABOVE BORDER TO BE PRINTED EXACTLY AS SHOWN ON 8.5x11 WHITE 16 POUND NON-BOND RECYCLABLE PAPER. PRINT ON BOTH SIDES, EXCLUDING TEMPLATES. TO BE UNITIZED IN ACCORDANCE WITH GMSPO SPECIFICATIONS.

DATE	REVISION	AUTH	DR

TITLE	
INSTALLATION INSTRUCTIONS Personal Audio Link (PAL)	
PART NO.	19201501
SHEET	18 OF 21

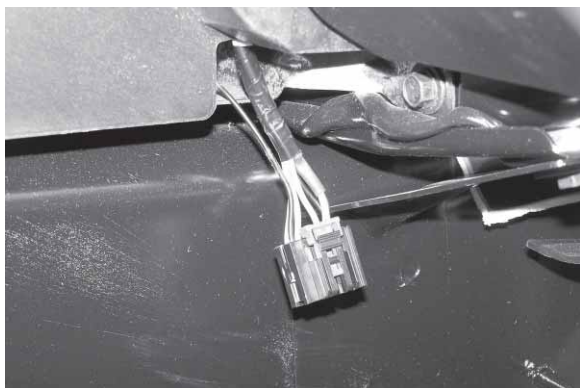
FIGURA 18



7. Tome un arnés de cable de 16 clavijas y páselo a través de la abertura que se encuentra cerca de la esquina inferior izquierda de la guantera. Figura 19.

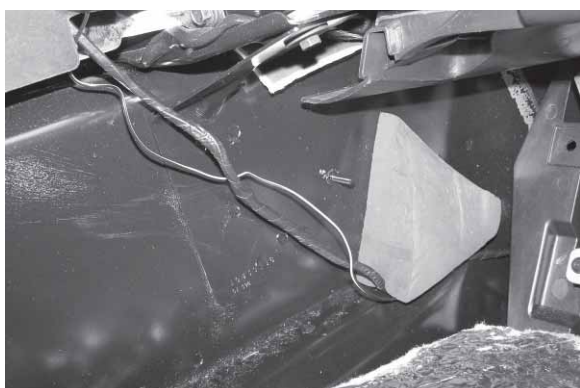
NOTA: TENGA PRECAUCIÓN CUANDO EL CABLE PUEDA TENER CONTACTO CON CUALQUIERA DE LOS BORDES AFILADOS.

FIGURA 19



8. Enrute el cable del arnés PAL de 16 clavijas hacia la parte lateral de la consola central y coloque debajo del bloque de espuma. Figura 20.

FIGURA 20



9. Continúe enrutando detrás del panel eléctrico de plástico y deje suficiente exceso de cable para conectar el módulo en un paso posterior. Figura 21.

FIGURA 21



PASO 9 – Instale el cable del iPod en la guantera
Procedimiento

1. Coloque la plantilla en el área exterior de la esquina inferior izquierda de la guantera y perforo un agujero con una broca de 13/16. Figura 22.

FIGURA 22



Alinee aquí

2. Inserte el conector del iPod de la guantera interior. Figura 23.

FIGURA 23



Personal Audio Link (PAL)

IR23JN08

PART NO.

19201501

SHEET

19 OF **21**

ALL INFORMATION WITHIN ABOVE BORDER TO BE PRINTED EXACTLY AS SHOWN ON 8.5x11 WHITE 16 POUND NON-BOND RECYCLABLE PAPER. PRINT ON BOTH SIDES, EXCLUDING TEMPLATES. TO BE INITIALIZED IN ACCORDANCE WITH GMSPO SPECIFICATIONS.

DATE	REVISION	AUTH	DR

TITLE	
INSTALLATION INSTRUCTIONS Personal Audio Link (PAL)	
PART NO.	19201501
SHEET	19 OF 21

3. Jale el conector del iPod a través y asiente la eslinga en el agujero. Figura 24.

FIGURA 24

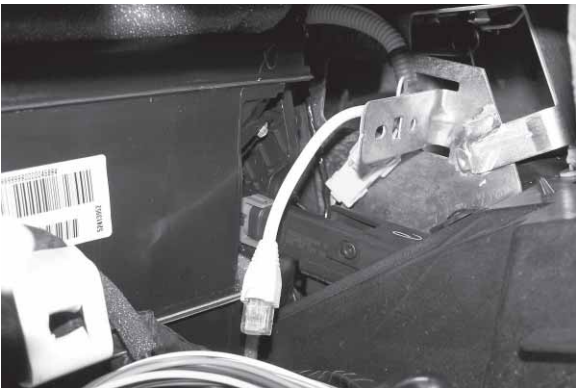


4. Enrute el conector del iPod a través de la abertura rectangular dentro de la cavidad en la guantera en el I/P. Figura 25 y Figura 26.

FIGURA 25



FIGURA 26



5. Enrute el conector del iPod a través de la abertura en donde la esquina inferior de la consola central se junta con el lado inferior izquierdo del área de la guantera y enrute el conector del iPod hacia el lateral de la consola central y coloque debajo del bloque de espuma. Figura 27.

FIGURA 27



6. Continúe enrutando detrás del panel de plástico y deje suficiente cable excesivo para conectar el módulo en un paso posterior. Figura 28.

FIGURA 28



PASO 10 – Instale la guantera

Procedimiento

1. Jale el conector del iPod excesivo a través y deje suficiente largo para dejar que se abra y cierre la guantera. Figura 29.

FIGURE 29



Personal Audio Link (PAL)

IR23JN08

PART NO.

19201501

SHEET

20 OF 21

ALL INFORMATION WITHIN ABOVE BORDER TO BE PRINTED EXACTLY AS SHOWN ON 8.5x11 WHITE 16 POUND NON-BOND RECYCLABLE PAPER. PRINT ON BOTH SIDES, EXCLUDING TEMPLATES. TO BE UNITIZED IN ACCORDANCE WITH GMSPO SPECIFICATIONS.

DATE	REVISION	AUTH	DR

TITLE	
INSTALLATION INSTRUCTIONS Personal Audio Link (PAL)	
PART NO.	19201501
SHEET	20 OF 21

2. Vuelva a instalar la guantera. Figura 30.

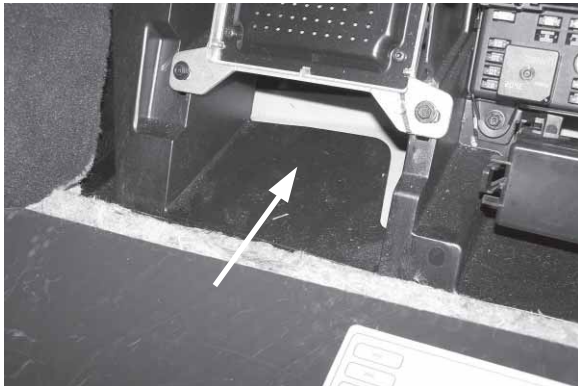
FIGURA 30



PASO 11 – Preparación para la instalación del módulo

1. Limpie el área de montaje con activador de adhesión. Figura 31.

FIGURA 31



2. Conecte ambos conectores en el módulo PAL. Figura 32.

FIGURA 32



3. Retire la cinta adhesiva de la parte inferior del módulo PAL y coloque el módulo como se muestra con el cable del iPod hacia el frente en el vehículo y el conector de 16 clavijas orientadas hacia la parte trasera del vehículo. Asegúrese de que el módulo o arnés no salgan más allá del soporte de plástico de manera que la alfombra del piso esté asentada correctamente. Figura 33.

FIGURA 33



PASO 12 – Vuelva a instalar los componentes del vehículo

- Panel lateral inferior delantero del piso
- Unidad de HVAC
- Radio de navegación
- Placa de acabado
- Cubierta de la palanca del freno de estacionamiento
- Panel de acabado central
- Alfombra de acabado central del lado del pasajero
- Panel de cierre
- Conexión de borne negativo de la batería
- Placa de acabado de accesorios

PASO 13 - Revisión final rápida del dispositivo

1. Si no tiene un iPod conectado, observará "Sin iPod" en la pantalla cuando presione la tecla programable de bandas de XM2.
2. Si hay un iPod disponible, entonces después de conectar el iPod y tener encendida la ignición, presione la tecla programable de bandas de XM2 y luego deberá de aparecer la pantalla iPod User Interface (Interfaz del usuario de iPod).

Personal Audio Link (PAL)

IR23JN08

PART NO.

19201501

SHEET

21 OF 21

ALL INFORMATION WITHIN ABOVE BORDER TO BE PRINTED EXACTLY AS SHOWN ON 8.5x11 WHITE 16 POUND NON-BOND RECYCLABLE PAPER. PRINT ON BOTH SIDES, EXCLUDING TEMPLATES. TO BE UNITIZED IN ACCORDANCE WITH GMSPO SPECIFICATIONS.

DATE	REVISION	AUTH	DR

TITLE	
INSTALLATION INSTRUCTIONS Personal Audio Link (PAL)	
PART NO.	19201501
SHEET	21 OF 21